

Modular Panel Meter Series EDM 35

ENGLISH

CONTENTS	Page
1. Introduction	2
1.1 Getting Started	2
1.2 Overall Description	3
1.3 Features	3
1.4 Block Schematic	4
2. Unit Description	4
2.1 Modules	4
2.2 Main Unit	7
3. Installation & Operations before Use	9
3.1 Procedure	9
3.2 Installation	9
3.3 Rated Operational Voltage	10
3.4 Jumper Setting on Modules	10
3.5 Input Range Selection	15
4. Operation & Programming	16
4.1 Switching On	16
4.2 Operating Modes	16
4.3 Programming	21
5. Application Hints	26
5.1 Applications - DC Ammeters	26
5.2 Applications - AC Ammeters	27
6. Ordering Keys	28
6.1 Modules	28
6.2 System EDM 35	29
7. Specifications	32
7.1 Main Unit Specifications	32
7.2 Module Specifications & Scaling Values	34
7.3 Mechanical Dimensions	43
8. Appendix	44
8.1 Reset of Password	44
8.2 Quick Reference Guide	45

1 Introduction

1.1 Getting Started

How to prepare the EDM 35 for use

For convenience you have a check list below to be sure that all preparations of the EDM are made before the application. Page references are mentioned so you can easily find the point in question in this manual. If the EDM is received in modules start at point 1, otherwise start at point 6.

- | | |
|--|---|
| 1. Select all modules necessary for the application. | 6 Ordering Keys
Page 28 |
| 2. Set jumpers on the input module and if used also on the excitation output module and/or the analogue output module. | 3.4 Jumper Setting on Modules
Page 10 |
| 3. Insert all modules according to the drawing printed on the module: <ul style="list-style-type: none"> • Power supply first (then from right to left). • Mount blind covers in non-used slots. | 2.1.3 Modules and Slot Position
Page 6 |
| 4. Fill out the label on the main unit and the shipping box with missing information (ordering key for system, power supply, input and output modules and ranges). Easy access to this information might help you later. | 6.2 Ordering Key for System EDM 35
Page 29
3.4 Jumper Setting on Modules
Page 10 |
| 5. Insert engineering unit in the front cover and mount this. | 3.2 Installation
Page 9 |
| 6. The program needs information about the actual input range. Check input range selection and change if necessary. | 3.5 Input Range Selection
Page 15 |
| 7. Program panel meter to suit the application. | 4 Programming
Page 16 |

1.2 Overall Description

The EDM series 35 is based on a modular concept consisting of a main unit and plug-in modules. The concept provides the meter with high flexibility and versatility. The offer of input-, output- and power supply modules makes it possible to configure the meter to suit most applications.



Furthermore, the modular concept ensures that the stock costs are minimized.

1.3 Features

The main features of the EDM series 35 are:

- Modularity
- Continuous measurement and monitoring of the analog signal of the input variable
- Continuous monitoring of the measured value for exceeding the programmed setpoint values
- Setpoints individually programmable: Value, hysteresis, high/low alarm, time delay
- Separate programming of each output relay: energized/deenergized and status in overflow condition
- Additional software functions: scaling, data hold and peak/valley
- Input modules for measuring voltage (AC or DC), current (AC or DC), resistance, temperature (Pt 100 or thermocouple J or K), frequency or revolutions per minute
- Output modules with 1 or 2 relays or with analogue output (4 - 20 mA, 0 - 20 mA, 0 - 10 V)
- Power Supply modules for AC or DC supply as well as excitation supply for sensor supply
- Interface to Carlo Gavazzi's Dupline® Field and Installation Bus

The large variety of input signals of both electrical and industrial process variables make the EDM an extremely versatile instrument suitable for many applications.

The characteristics of the instrument are complemented by its easy programming and configuration in accordance with the application.

1.4 Block Schematic

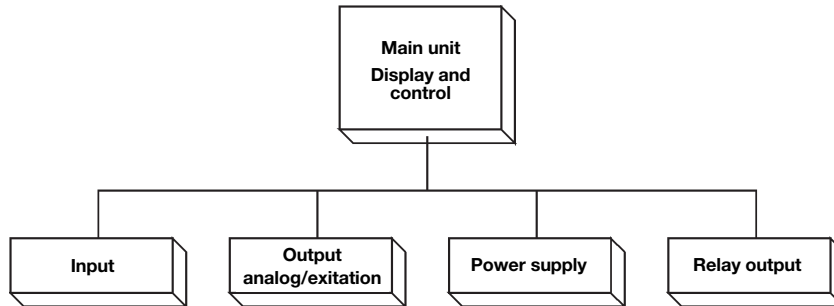

2 Unit Description

2.1 Modules

2.1.1 Common description

The modules are parted into 3 categories: Power supply modules, input modules and output modules. Each module is dedicated to its own function or input variable.

To minimize the number of modules many input modules are designed to cover all ranges. If you want to change the input range just press the locking tabs and pull out the module to change a jumper position, reinstall the jumper and reprogram the range selection. If you change the range from low to high level or vice versa it might be necessary for you to use other terminal positions as well.

The input modules are available with terminals for program lock to protect against unauthorized admittance.

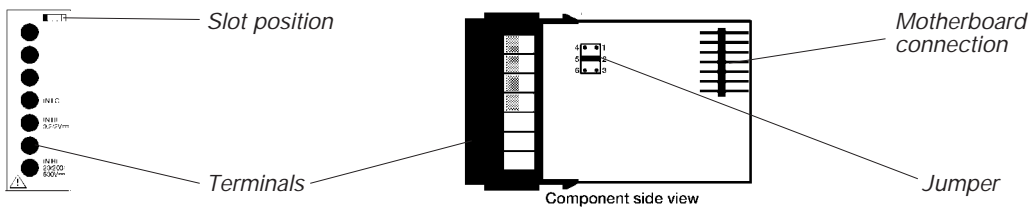

All modules are easy to plug in - for your information the slot position is marked on the drawing on the rear of the module.

2.1.2 Variants

2.1.2.1 Power Supply Modules

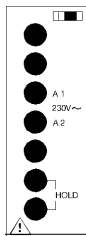

You will always need the power supply module. These are available for the most common supply voltages. Due to the size of the transformer the power supply module always occupies 2 slots.

2.1.2.2 Input Modules

The input modules are divided into the following categories:

- Voltmeters (AC or DC)
- Ammeters (AC, DC or 10A AC/DC)
- Ohmmeters
- Thermometers (Pt 100, Thermocouple J or K)
- Frequency - and Tachometers
- Dupline® Analink Interface

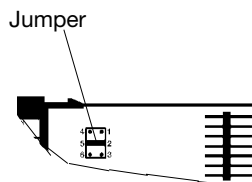

For voltmeters, ammeters, ohmmeters, frequency - and tachometers a jumper in the module determines the actual range for the module. Switching from one range to another also means that you are switching from one input circuit to another input circuit.

For ammeters 10 A AC/DC the jumper determines whether you are measuring AC current or DC current. The thermometers do not include a jumper - here the range is changed only through the programming.

For the Dupline® Analink interface module only the channel number has to be coded on two rotary switches.

All input modules occupy 1 slot and they are always placed at left (rear view of the main unit).

2.1.2.3 Output Modules

The output modules are divided into the following categories:

- Relay output (1 or 2 relays)
- Analogue output (4-20 mA, 0-20 mA and 0-10 V)
- Excitation output (for sensor supply)

Depending upon the application you can choose between different output types: An output module with 1 or 2 relays and/or an output module with analogue output where you are able to select the required type of analogue output with the jumpers. The relay output module is always placed at right (rear view of the main unit).

With the excitation output module inserted you are able to supply for example sensors which are a part of the application. With a jumper you can select 12 or 24 VDC. This module shares slot #2 with the analogue output module.

2.1.3 Modules and Slot Position

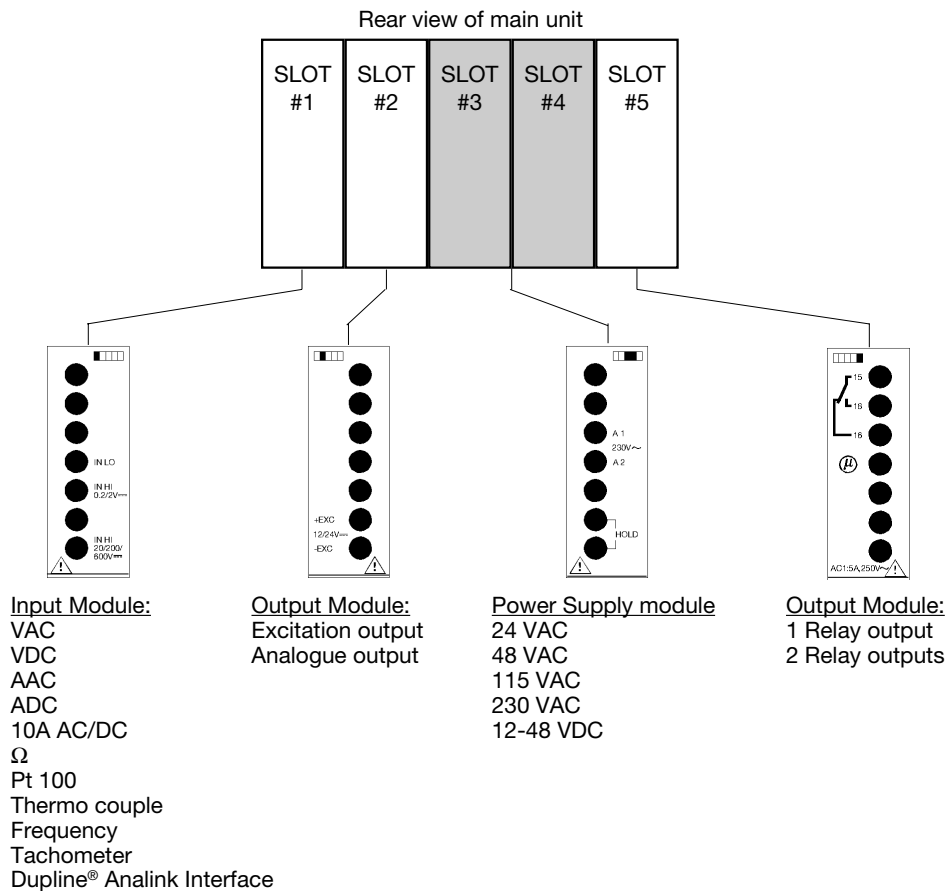

2.2 Main Unit

2.2.1 Description

The main unit includes a 3 1/2 digit, 7-segment display with alarm indicators, a motherboard for 1 power supply module and 3 input/output modules, a processing unit and a keyboard.

You can use the main unit as a 3 1/2 digit indicator when inserting only a power supply module and an input module. If you extend the system with a relay output module and/or an analogue output module, you have a 3 1/2 digit controller.

The main unit is delivered with 1 front cover, 1 manual, 2 mounting brackets, 2 gaskets for sealing, 1 set of engineering unit labels and 3 blind covers for unused slots.

2.2.2 Variants

The main unit is available in 3 different variants. The 3 types are:

Standard red display
High bright red display
Green display

2.2.3 Front Panel Description

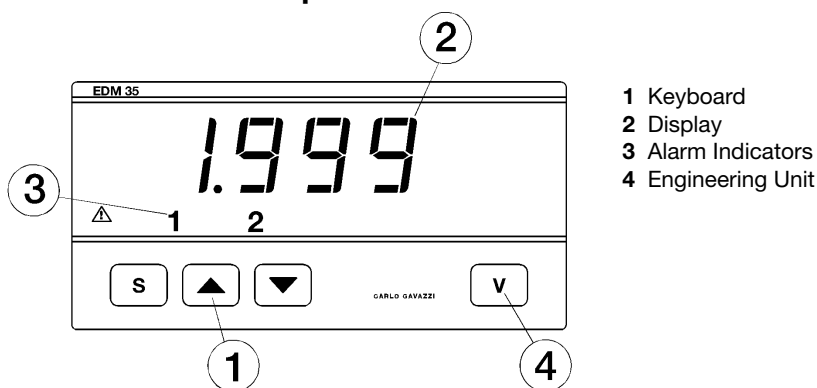

1 Keyboard

- S** Set/Enter: Entry of variables
Selecting programming functions
- ▲** Up/Down: Up/down keys for display control
- ▼** Increasing and decreasing programming values

② Display

3 1/2 digit (max. read-out 1999). Alphanumeric indication of:

- Measured value
- Programming parameters

③ Alarm Indicators

Indicates when an alarm condition occurs.

“1” indicates alarm condition when a 1-relay output module is used (= 1 set point).

“1” and “2” indicate alarm condition when a 2-relay output module is used (= 2 set points).

④ Engineering Unit

Interchangeable unit label. A set of engineering unit labels is supplied with the EDM. The engineering unit has to be inserted by the customer.

3 Installation & Operations before Use

3.1 Procedure

Before the instrument is ready for use, i.e. before it is ready for the application dependent programming, you have to prepare the instrument physically (engineering unit, modules etc.) - this is described in chapter **3.2 Installation**.

Before you are connecting the instrument to the mains or the power supply you have to be sure that the right power supply module is used. This is discussed in chapter **3.3 Rated Operational Voltage**.

You have to check the jumper settings on some of the modules. The range selected must be in accordance with your application. The jumper setting is shown in chapter **3.4 Jumper Setting on Modules**.

After you have set the jumpers the processing unit must know which range you have selected. This “range code” has to be entered in the software when the instrument is turned on. Further information will be given to you in chapter **3.5 Input Range Selection**.

3.2 Installation

First, if desired, you insert the engineering unit (3). You can choose a unit from the set of engineering unit labels.

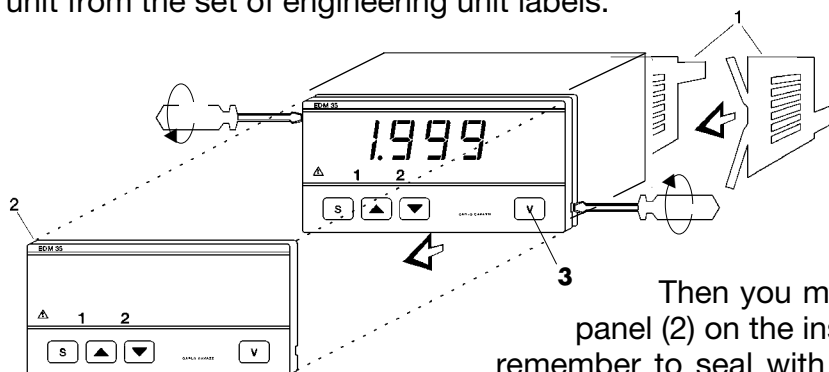

Then you mount the front panel (2) on the instrument - remember to seal with the enclosed gasket (the largest of the two enclosed). Place the remaining gasket round the body of the instrument and slide instrument into the panel aperture. **To optimize the tightness be sure that the panel cut-out is completed and deburred. Be also aware that a too thin panel may distort and not provide sufficient sealing.**

Fasten the instrument with the two brackets (1).

If you later want to replace the engineering unit (3), you insert a screwdriver into the lateral slot in the front panel and turn (be careful!) the screwdriver as shown until the front panel has been completely removed. Replace the engineering unit.

You can find the panel cutout and the mechanical dimensions in chapter 7.3 Mechanical Dimensions.

3.3 Rated Operational Voltage

Before you switch on the instrument, make sure that the supply voltage corresponds to the rated operational voltage indicated on the power supply module.

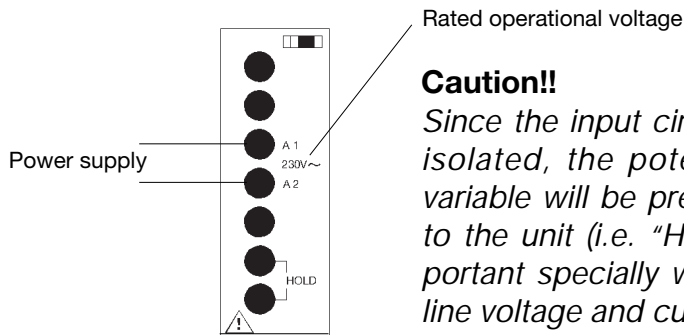

Caution!!

Since the input circuitry is not galvanically isolated, the potential of the measured variable will be present on all connections to the unit (i.e. "HOLD" input). This is important specially when you are measuring line voltage and current.

3.4 Jumper Setting on Modules

As some modules are designed to cover several ranges it can be necessary for you to select the required range by moving an internal jumper. The major part of the input modules, the excitation output module and the analogue output module have this possibility for range selection. On the following pages the jumper setting is shown for the modules:

- 3.4.1 Voltmeters
- 3.4.2 Ammeters
- 3.4.3 Ohmmeters
- 3.4.4 Frequency - and tachometers
- 3.4.5 Dupline® Analink Interface module
- 3.4.6 Output modules

Note! Always remember to turn off the power supply before you plug in or pull out the modules.

3.4.1 Voltmeters

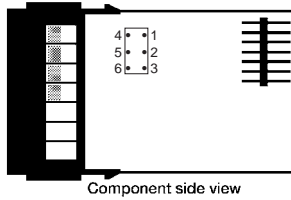

Voltmeters

VDC input module 5100530/630

VAC input module 5100531/631

Input Range	Jumper position
200 mV	
2 V	
20 V	
200 V	
600 V	

3.4.2 Ammeters

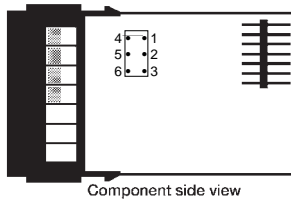

Ammeters 0 - 5 A

ADC input module 5100532/632

AAC input module 5100533/633

Input Range	Jumper position
200 μ A	
2 mA	
20 mA	
200 mA	
2 A	
5 A	

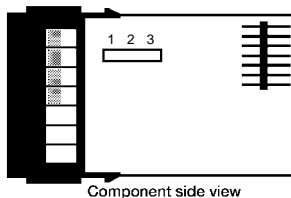

Ammeters 10 A

10 A AC/DC input module 5100534/634

Input Range	Jumper position
10 AAC	
10 ADC	

3.4.3 Ohmmeters

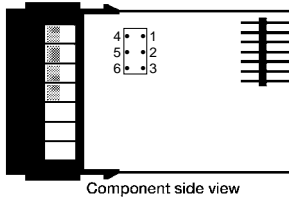

Ohmmeters

Ohm input module 5100535/635

Input Range	Jumper position
200 Ω	
2 kΩ	
20 kΩ	
200 kΩ	

3.4.4 Frequency - and Tachometers

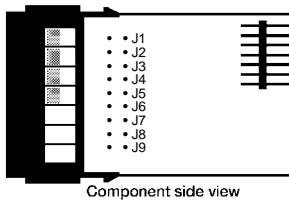

Frequency Meter

Input module 5100541/641

Range	Jumper position
199.9 Hz	
1999 Hz	

Frequency Meter

Input module 5100541/641

Input	Jumper position
Namur	
NPN, PNP contact	
600 VAC	

3.4.4 Frequency - and Tachometers (cont.)

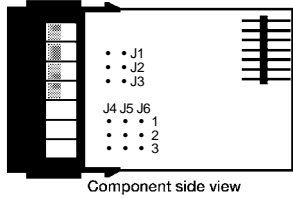

rpm: Revolutions per minute
ppr: Pulses per revolution

Tachometer Input module 5100540/640

Range	Jumper position
199.9 rpm 30 ppr	J4 J5 J6 • • • 1 • • • 2 • • • 3
199.9 rpm 60 ppr	J4 J5 J6 • • • 1 • • • 2 • • • 3
199.9 rpm 100 ppr	J4 J5 J6 • • • 1 • • • 2 • • • 3
1999 rpm 30 ppr	J4 J5 J6 • • • 1 • • • 2 • • • 3
1999 rpm 60 ppr	J4 J5 J6 • • • 1 • • • 2 • • • 3
1999 rpm 100 ppr	J4 J5 J6 • • • 1 • • • 2 • • • 3

Tachometer Input module 5100540/640

Input	Jumper position
Namur	J1 • • • J2 • • • J3
NPN, PNP contact	• • • J1 • • • J2 • • • J3

3.4.5 Dupline® Analink Interface Module

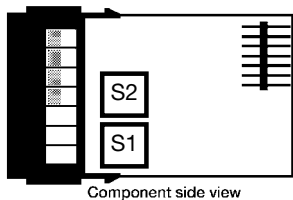

Analink EDM 35 Plug-in Card Input module G 2139 1139

Channel number	Switch position
S1: Group	A - P
S2: Channel	1 - 8

3.4.6 Output Modules

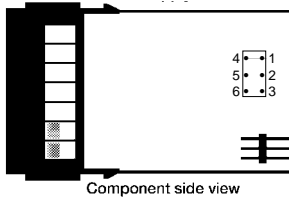

Component side view

Range determined by jumper only. No software programming necessary.

Excitation Power Supply

Output module 5100526

Output Voltage	Jumper position
12 VDC	
24 VDC	

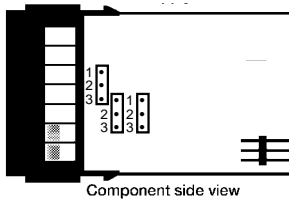

Component side view

Range determined by jumper only. No software programming necessary.

Analogue Output Module

Output module 5100560

Output	Jumper position
4 - 20 mA	
0 - 20 mA	
0 - 10 V	

3.5 Input Range Selection

When you have selected the range on the input module (according to 3.4 Jumper Setting on Modules) you have to update or check the programming to be sure that the programmed range code corresponds to the range selected with the jumpers on the module. This is accomplished in *calibration mode*. Other functions in calibration mode are discussed in chapter **8.1 Calibration Mode**. To change or check the programmed range follow the description below.

1. Press **S** and **▼** simultaneously and switch on the unit. The display shows **PR5**. Release the keys. The display shows **PR5** for 2 s and then **□**.
2. Press **▲** until '66' is displayed. Press **S** and the display now shows **SEL**.
3. Press **S** to accept your entry to selection of range code. Now the display shows the current range code (a number between 0 and 12).
4. Press **▲** or **▼** to select a range code between 0 and 12 according to the range selected on the module and the list below.

Range code	Temp.	VDC	VAC	ADC	AAC	10 A AC/DC	Ohm	Freq.	Tachometer	Dup-line
0	All									
1		0.2 V		0.2 mA						
2		2 V		2 mA						
3		20 V		20 mA						
4		200 V		0.2 A						
5				2 A						
6		690 V		5 A		10 ADC				
7			0.2 V		0.2 mA		200 Ω	200 Hz	200 rpm/30 ppr	All
8			2 V		2 mA		2 kΩ	2 kHz	200 rpm/60 ppr	
9			20 V		20 mA		20 kΩ		200 rpm/100 ppr	
10			200 V		0.2 A		200 kΩ		2000 rpm/30 ppr	
11					2 A				2000 rpm/60 ppr	
12			690 V		5 A	10 AAC			2000 rpm/100 ppr	

5. When the desired range code is displayed press **S**. The display shows **End** for 2 seconds and automatically returns to RUN-mode.

The range selection is now completed, and the panel meter is ready to use. Now you can go ahead with customizing the program.

— 4 Operation & Programming —

Chapter 4 describes the different operating modes for the EDM. The calibration mode is described in details in chapter 3.5 (Range Input Selection) and chapter 8 (Appendix).

This chapter includes

4.1 Switching On

4.2 Operating Modes

4.2.1 Measurement and Control

4.2.2 Programming Mode

4.2.2.1 Access to programming

4.3 Programming

4.3.1 New Password

4.3.2 Decimal Point Selection

4.3.3 Electrical Input Range (HiE and LoE)

4.3.4 Display Span (Hi and Lo)

4.3.5 Alarm Setpoint(s) - Controllers

4.3.5.1 Setpoint 1

4.3.5.2 Hysteresis

4.3.5.3 Time Delay

4.3.5.4 High and Low Alarm

4.3.5.5 Relay Normally energized/ de-energized

4.3.5.6 Relay Status in Overflow Condition

4.3.5.7 Setpoint 2

4.1 Switching On

When you switch on the unit, the display shows r u n for a few seconds, followed by the input signal value.

4.2 Operating Modes

The EDM can operate in 3 different modes: Measurement and control mode, programming mode and calibration mode.

The flowchart shows how you get access to the different modes of operation.

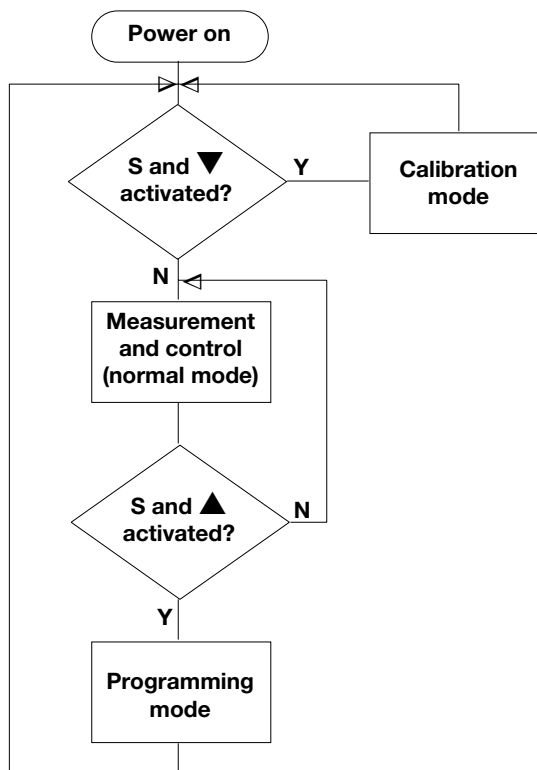

4.2.1 Measurement and Control

In the measuring and control operating mode the instrument has the following basic functions:

- Measurement of the input variable
- Display of the measured variable in the correct engineering unit
- Setpoint control with activation/deactivation of the alarm LED's and relays
- Detects when the input is out of range and indicating this with $\pm EE$ in the display. The relay status will be as the preprogrammed fault condition
- 'Hold' input detection
- Update of peak and valley function
- If analogue output module is present, repetition of the displayed value in analogue form

The **S**, **▲** and **▼** control the display. The normal function of the display is to indicate the measured input variable.

The following lines describe how you can use these for selecting information on the display during daily operation.

4.2.1.1 Setpoint 1 Value Read-out (SP1)



Press  and release.

After displaying the setpoint value for 2 seconds the instrument will return to display the input variable. Setpoint values are only shown if a relay output module (1 or 2 relays) is installed.

4.2.1.2 Setpoint 2 Value Read-out (SP2)

Press  and release.

4.2.1.3 Peak and Valley Values Read-out

Press  and  simultaneously and release.

4.2.1.4 Reset of Peak and Valley Values



Press ,  and  simultaneously and release.

The peak and valley values are reset during power-up as well.

4.2.1.5 Programming Mode Access

Press and hold ; then press . Release both immediately after the display shows .

4.2.1.6 Calibration Mode Access

Press  and  during power-up. Release both immediately after the display shows .

4.2.1.7 'Hold' Function

The 'Hold' function is standard for all versions and is located on the terminals of the power supply module. By short-circuiting the 'Hold' input, the indication on the display is frozen. When the 'Hold' function is active, all other functions operate in normal way.

4.2.1.8 Setpoints

The setpoints can operate in four different ways depending on the programming. See the following drawing.

Setpoint Operation

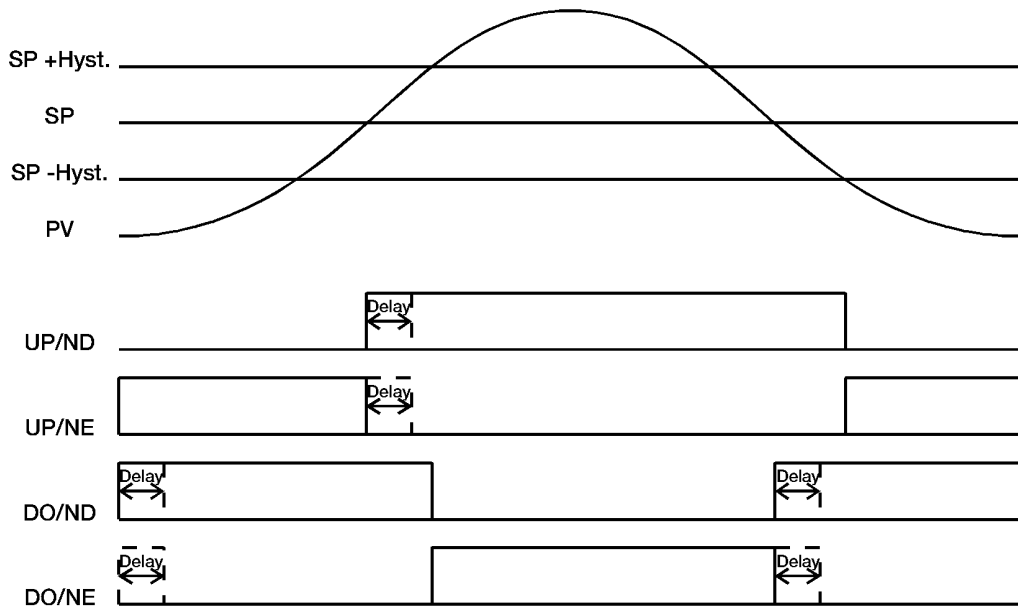

Scaling Operation

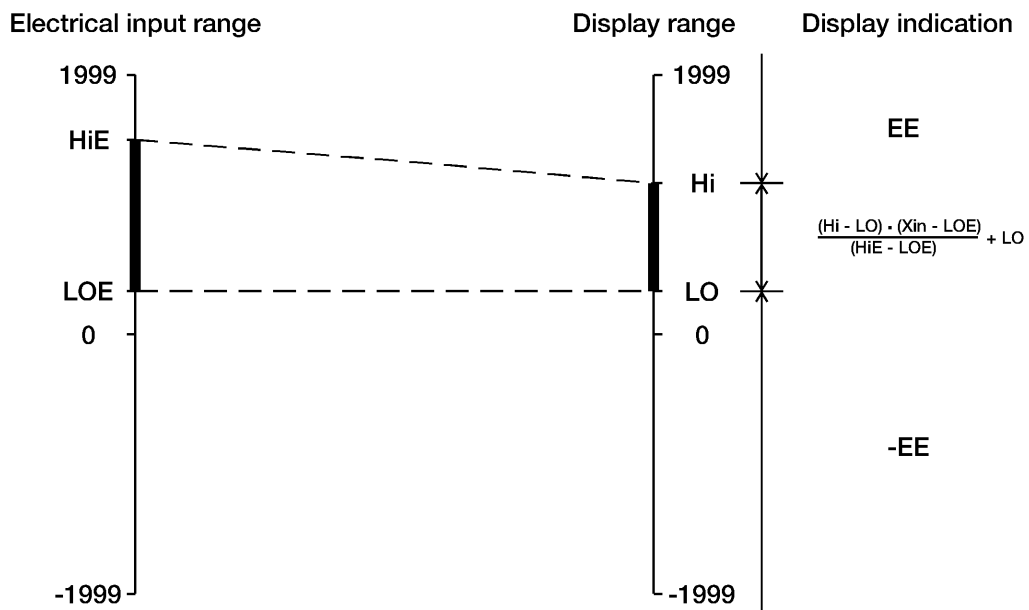

4.2.2 Programming Mode

The programming mode allows the user to define the instrument parameters:

- Password for access to programming
- Decimal point position
- Minimum and maximum values of the electrical input range
- Display span

and for each alarm setpoint:

- Setpoint
- High or low alarm levels
- Hysteresis
- Time delay
- Alarm relay normally energized/de-energized
- State of alarm relay in overflow conditions

Stepping from the programming of one parameter to the programming of the next happens by pressing **S**.

The normal measurement and control functions are not active in programming mode. The alarm outputs are OFF. The analogue output is low.

Termination of the programming mode and return to measurement and control mode follows automatically after completion of all programming steps or after 3 minutes without key activation.

The display will show **End** for 2 seconds.

4.2.2.1 Access to Programming Mode

1. Press and hold **S**; then press **▲**. Release both immediately after the display shows **PRG**.

During this phase the instrument asks for a password between 0 and 199 - the instrument is delivered with the password "0".

2. If the password is not set to zero, press **▲** and/or **▼** until the value (password) is displayed. Press **S** to enter.

If the entered password matches the stored password, the instrument automatically proceeds to the next step - otherwise it returns to measurement and control mode.

4.3 Programming

4.3.1 New Password

1. After you have entered the password the display shows **PAS**. After 2 s the stored value of the password is displayed. To retain the present value, press **S** to pass on to the next selection.
2. To modify the password, press **▲** and/or **▼** until the desired value is displayed; this has to be a number between 0 and 199. Press **S** to pass on to the next parameter.

A password between 100 and 199 gives direct access to setpoint programming in the following way: Enter programming mode and press 'S'. Then you will automatically jump directly to setpoint programming. After the setpoint programming the programming mode is terminated.

4.3.2 Decimal Point Selection

Decimal point selection is relative to the displayed value.

1. After selection of the password the display will show **dP** for 2 s. The current position of the decimal point is then indicated on the display by a steady light as **||||**.
2. Change the position of the decimal point using **▲** (shift to left) and/or **▼** (shift to right). Press **S** to enter and pass on to next.

4.3.3 Electrical Input Range (HiE and LoE)

This feature allows you to define an electrical input range different from the standard range. For example, for EDM with full-scale 20 mA (± 19.99 mA), it is possible to select an electrical input range from 4.00 mA to 19.99 mA by proceeding as follows:

1. After programming the decimal point the display shows **HiE** for 2 seconds signifying the maximum of the electrical input range. The **HiE** value stored in the memory is shown on the display, for example **129**. To retain the value shown, press **S** to pass on to next parameter.

2. To select a new value of **HiE**, press \blacktriangle and/or \blacktriangledown until the desired value is displayed, for example 19.99 . Press S to accept.
3. After programming the **HiE** the display shows LoE for 2 s signifying the minimum of the electrical input range.
The **LoE** value stored in the memory is then shown on the display.
To modify the **LoE** value proceed as described for the **HiE** value, but select the value 4.00 (according to the example).
Press S to accept the value and pass on to the next parameter.

Note! LoE and HiE values are shown in the same unit of measurement as the input module range.

4.3.4 Display Span (Hi and Lo)

This allows you to define the display span (in engineering units) corresponding to the previously defined electrical input range.

For example EDM 20 mA

Programmed electrical input range: 4.00 to 19.99 [mA]

Programmed display span: 0.00 to 8.00 [bar]





Lo: Displayed value corresponding to minimum of the input range (LoE).

Hi: Displayed value corresponding to maximum of the input range (HiE).

The display can be programmed within the instrument read-out range indicated in the technical data tables. Since the link between the electrical and the displayed value is completely adjustable/variable, it is possible to correlate a minimum electrical value to a maximum display value, and vice versa (scale inversion).

The best resolution is achieved when $\left| \frac{\text{HiE} - \text{LoE}}{\text{Hi} - \text{Lo}} \right| \geq 1$

1. After selecting the electrical input range, the display shows Hi for 2 s, signifying the maximum of the display span. The display then shows the **Hi** value stored in the memory. Press S to retain the current value.

2. To select a new **Hi** value, press  and/or  until the desired value is displayed. Press  to enter the value.
3. After entering the **Hi** value the display shows  for 2 s, signifying the minimum of the display span. The display shows the current value of **Lo**. To change or retain the **Lo** value proceed as described for **Hi**. After the entering of the value with  the instrument passes on to the next parameter.





4.3.5 Alarm Setpoint(s) - Controller

The EDM automatically senses if a relay output module is installed in the instrument, and programming mode proceeds to entry of the data relating to the setpoints.

If no relay output module is installed, programming mode will be terminated after the display span programming.

Note! The setpoint is relative to the display span, and not to the electrical input range.

4.3.5.1 Setpoint

1. After programming the display span the display shows  for 2 s, indicating that the current programming concerns setpoint 1.
The display will then show the stored setpoint value.
To retain the value shown, press  .
2. To select a new value for **SP1**, press  and/or  until the desired value is displayed. Press  to accept and pass on to the next parameter.

4.3.5.2 Hysteresis

The hysteresis is the difference between the programmed setpoint value (the value at which the alarm is set ON) and the value at which the alarm is disabled. The hysteresis is related to the display span and it is an absolute value. See drawing on page 17.

1. The display shows **H95** for approx. 2 s. The display then shows the current value stored in the memory.
Accept the value by pressing **S** .
2. To select a new value for the hysteresis press **▲** and/or **▼** until the desired value is displayed. Now press **S** to accept this value and pass on to the next parameter.

4.3.5.3 Time Delay

1. When entering this parameter (from 0 to 99 s) the display will show **dEL** for approx. 2 s. Then the display shows the current value stored in the memory - the value is expressed in seconds.
To accept this value press **S** .
2. If you wish to change the value, press **▲** and/or **▼** until the required value is displayed.
Press **S** to enter the value and pass on to the next selection.

4.3.5.4 High and Low Alarm

1. When you exit from the time delay programming the display shows **LP** if a high alarm is the current status or **dQ** if the low alarm is the current status.
To continue with the current status, press **S** and go on with the next parameter.
2. To change the status, press **▲** or **▼** to switch the status.
Press **S** to accept and pass on to the next parameter.

4.3.5.5 Alarm Relay Energized/De-energized

You can choose if the relay has to be energized or de-energized in the absence of an alarm.

1. The display will show **nd** for a normally energized relay or it will show **nd** for a normally de-energized relay.
Press **S** to keep the current value.

2. To select a new relay status, press to select the normally energized status (the display will show) or press to select the normally de-energized status (the display will show).
Press to accept and pass on to the next selection.

4.3.5.6 Relay Status in Overflow Condition

You can choose how the relay shall react in overflow conditions as well, namely whether the relay has to be ON or OFF.

1. The display will show for relay **ON** in overflow conditions or it will show for relay **OFF** in overflow conditions.
Press to keep the current value and pass on.
2. If you will change the status, press to select relay ON (the display will show) or press to select relay OFF (the display will show). Press to terminate setpoint 1 programming.

All parameters are now programmed (with a 1 relay output module installed) and the programming mode is terminated automatically. This will be shown in the display with . The system restarts and is back in run-mode.

4.3.5.7 Setpoint 2

If a 2 relay output module is installed the display will show after the termination of 4.3.5.6 Relay Status in Overflow Condition.

To select the parameters for setpoint 2, proceed as explained for setpoint 1.

After programming all parameters for setpoint 2, the programming mode is terminated automatically and shown in the display as .

The system restarts and is back in run-mode.

5 Application Hints

5.1 DC Ammeters with current output transducers

5.1.1

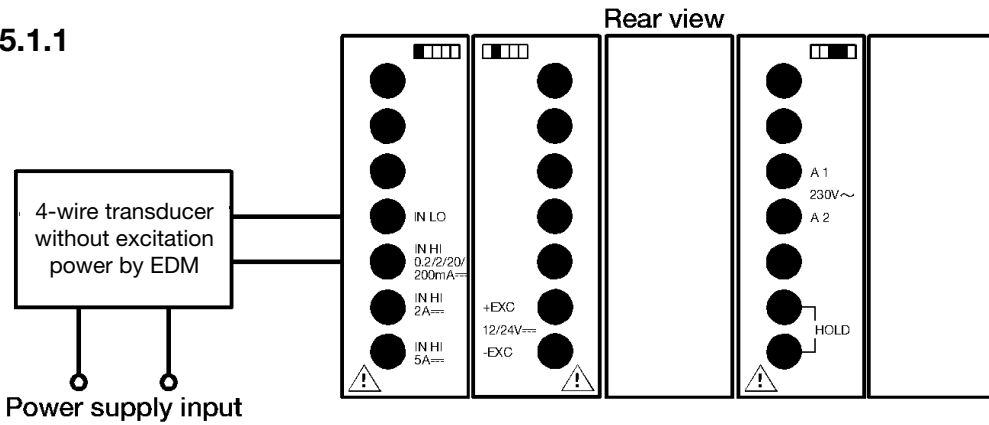

If the instrument has to be connected to 4-wire transducers, connect to screw terminals as shown in the figure.

5.1.2

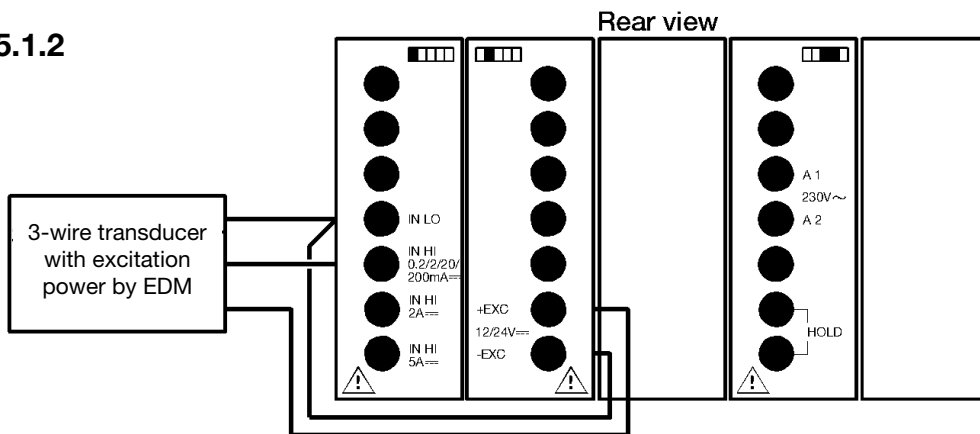

If the instrument has to be connected to 3-wire transducers powered by the instrument, connect to screw terminals as indicated.

5.1.3

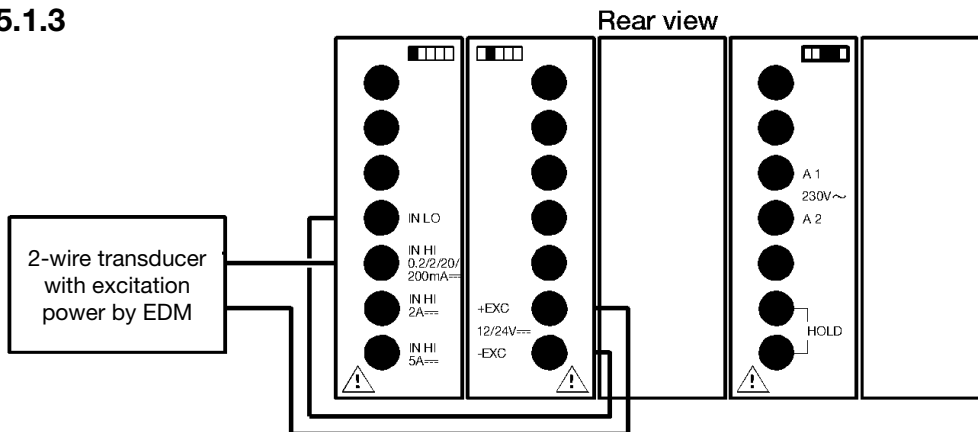

Connect as indicated if the instrument has to be connected to 2-wire transducers powered by the instrument.

Note:

The shown configuration is only for EDM with 20 mA input.

5.2 AC Ammeter with 5 AAC input

5.2.1

The electrical FS of this instrument is **HiE** = 1999; to maintain maximum resolution, this value should not be modified (during programming).

If the instrument is connected to a current transformer (5 AAC secondary current) with a primary current of 5-250 AAC, the display span should be programmed so that the **Hi** value corresponds to the input value of the CT primary.

Example:

Electrical full-scale: 0 - 5 AAC

LoE = 0

HiE = 19.99

Display span: 0 - 250 AAC

Lo = 0

Hi = 250 (250 (Hi) = 250 A CT primary)

See also 4.1 Modes of Operation: Scaling Operation

6 Ordering Keys

As the EDM is modular, you can assemble a unit of modules without using tools. All ranges of the input modules are calibrated from the factory.

EDM Components

A basic EDM indicator consists of a main unit, an input module and a power supply module. The mechanical components are included in the main unit. To the basic system you can add: analogue output, one or two relay outputs and excitation power supply for connected sensors (analogue output excludes the excitation output module).

6.1 Ordering Key for Modules

Display Modules (Main Unit): Part Number (includes mechanical parts)

3 1/2-digit display (green)	5100710
3 1/2-digit display (standard red)	5100711
3 1/2-digit display (high-bright red)	5100712

Power Supply Modules: Part Number

230 VAC	5100520
115 VAC	5100521
48 VAC	5100522
24 VAC	5100523
12 - 48 VDC	5100524

Input Modules:	Part Number	Part Number (with Program Lock)
VDC	5100530	5100630
VAC	5100531	5100631
ADC	5100532	5100632
AAC	5100533	5100633
10 A AC/DC	5100534	5100634
Ohm	5100535	5100635
Pt 100	5100536	5100636
Pt 100 850°C	5100539	5100639
Thermocouple Type J (Fe-CuNi)	5100537	5100637
Thermocouple Type K (NiCr-Ni)	5100538	5100638
Frequency meter	5100541	5100641
Tachometer	5100540	5100640
Dupline® Analink Interface		G 2139 1139

6.1 Ordering Key for Modules (continued)

Output Modules:	Part Number
1 Relay	5100561
2 Relays	5100562
Analogue Output	5100560
12/24 VDC Excitation Output	5100526

6.2 Ordering Key for System EDM 35

If you want to order a custom designed system, ready for use, you can construct a system ordering key from the following information.

EDM 35	V1D	4	1	X	XXY
A: Model number	B: Range (EDM)	C: Power supply	D: Relay output	E: Output signal	F: Other options and/or special designs

A: Model number **EDM 35** Carlo Gavazzi digital meter 3 1/2 digit

B: Range (EDM)

DC voltmeters	V1D:	-199.9 to 199.9 mV
	V2D:	-1.999 to 1.999 V
	V3D:	-19.99 to 19.99 V
	V4D:	-199.9 to 199.9 V
	V5D:	-600 to 600 V *

* Nominal voltage according to IEC 664-1. The measuring range includes 15% tolerance equal to 690 V

AC voltmeters	V1A:	0 to 199.9 mV
	V2A:	0 to 1.999 V
	V3A:	0 to 19.99 V
	V4A:	0 to 199.9 V
	V5A:	0 to 600 V *

* Nominal voltage according to IEC 664-1. The measuring range includes 15% tolerance equal to 690 V

B: Range (EDM) (cont.)

DC ammeters	A1D:	-199.9 to 199.9 μ A
	A2D:	-1.999 to 1.999 mA
	A3D:	-19.99 to 19.99 mA
	A4D:	-199.9 to 199.9 mA
	A5D:	-1999 to 1999 mA
	A6D:	-5.00 to 5.00 A
	A7D:	-9.99 to 9.99 A
AC ammeters	A1A:	0 to 199.9 μ A
	A2A:	0 to 1.999 mA
	A3A:	0 to 19.99 mA
	A4A:	0 to 199.9 mA
	A5A:	0 to 1999 mA
	A6A:	0 to 5.00 A
	A7A:	0 to 9.99 A
Ohmmeters	R1D:	0 to 199.9 Ω
	R2D:	0 to 1.999 k Ω
	R3D:	0 to 19.99 k Ω
	R4D:	0 to 199.9 k Ω
Frequency meters	F1A:	5.0 to 199.9 Hz, Namur
	F1B:	5.0 to 199.9 Hz, NPN, PNP, Contact
	F1C:	5.0 to 199.9 Hz, 600 VAC
	F2A:	10 to 1999 Hz, Namur
	F2B:	10 to 1999 Hz, NPN, PNP, Contact
	F2C:	10 to 1999 Hz, 600 VAC
Tachometers	Namur input:	
	T1A:	8.0 to 199.9 rpm, 30 pulses/revol.
	T2A:	5.0 to 199.9 rpm, 60 pulses/revol.
	T3A:	2.0 to 199.9 rpm, 100 pulses/revol.
	T4A:	20 to 1999 rpm, 30 pulses/revol.
	T5A:	10 to 1999 rpm, 60 pulses/revol.
	T6A:	10 to 1999 rpm, 100 pulses/revol.
	NPN, PNP & Contact input:	
	T1B:	8.0 to 199.9 rpm, 30 pulses/revol.
	T2B:	5.0 to 199.9 rpm, 60 pulses/revol.
	T3B:	2.0 to 199.9 rpm, 100 pulses/revol.
	T4B:	20 to 1999 rpm, 30 pulses/revol.
T5B:	10 to 1999 rpm, 60 pulses/revol.	
T6B:	10 to 1999 rpm, 100 pulses/revol.	
Dupline Interface	To be ordered separately	

C: Power supply	3:	12 to 48 VDC
	4:	230 VAC
	5:	115 VAC
	6:	48 VAC
	7:	24 VAC
D: Relay output	0:	None
	1:	1 relay
	2:	2 relays
E: Output signal	X:	None
	1:	4 - 20 mA
	2:	0 - 20 mA
	4:	0 - 10 V
	5:	12 VDC excitation output
	6:	24 VDC excitation output
F: Options	XXY:	None
	CXY:	High bright red display
	DXY:	Green display
	XPY:	Program lock
	01Y-99Y:	Special designs (assigned by factory)

Ordering Key Example

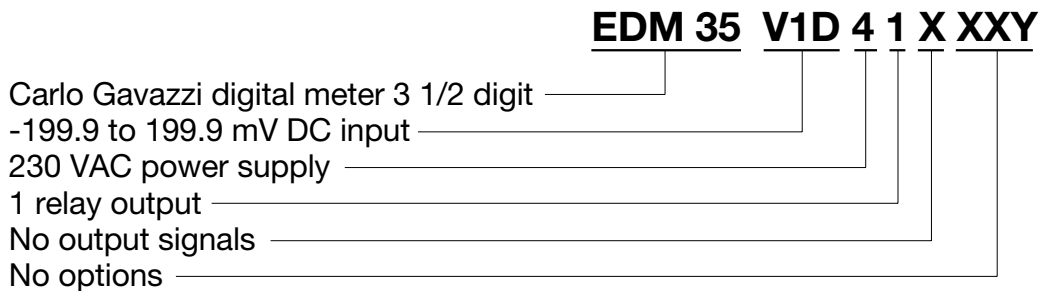

7 Specifications

7.1 Main Unit

7.1.1 General Specifications

Modular Panel Meter	3 1/2 digit indicator/controller.	
Display	7-segment, height 14.2 mm, red LED. 2 red LED's for indication of relay ON.	
	Optional:	
	1) High bright red display and LED's.	
	2) Green display and 2 yellow LED's.	
Max. and min. indication	-1999 to 1999	
A/D converter	Special dual slope. Approx. 2 display/relay updates per second.	
Accuracy	See module specifications.	
Warm-up to rated accuracy	Current: 10 minutes; voltage: 2 minutes.	
CMRR	100 dB	GR = 1 k Ω .
NMRR	50 dB	GR = 50 Ω .
Temperature drift	See module specifications.	
Excitation output	See module specifications.	
<hr/>		
Degree of protection	IP 65 (front), IP 20 (behind panel).	
Operating temperature	0 °C to 50°C (32°F to 122°F). (R.H. < 90% non-condensing).	
Storage temperature	-10°C to 60°C (14°F to 140°F). (R.H. < 90% non-condensing).	
<hr/>		
Approvals	UL, CSA.	
<hr/>		
Weight	Approx. 350 g. (affected by configuration).	
Housing dimensions	48 x 96 x 89 mm.	
Housing material	ABS/Polycarbonate blend.	
<hr/>		

Housing colours	Black (front red, optional green).
Module connection	Screw terminals.

7.1.2 Supply Specifications

Rated operational voltage	230 VAC ± 10%, 50/60 Hz ± 5 Hz (5100520). Also usable at line voltages of: 240 VAC +6/-15%, 220 VAC +15/-6%. 115 VAC ± 10%, 50/60 Hz ± 5 Hz (5100521). Also usable at line voltages of: 120 VAC +6/-15%, 110 VAC +15/-6%. 48 VAC ± 10%, 50/60 Hz ± 5 Hz (5100522). 24 VAC ± 10%, 50/60 Hz ± 5 Hz (5100523). 12 to 48 VDC ± 15% (5100524).
----------------------------------	---

Rated operational power 6 VA (12 to 48 VDC: 6 W).

7.1.3 Programming Specifications

Scaling

Electrical input range	Prog. within the whole measuring range.
Display range	Programmable within the whole scale.
Decimal point position	Programmable

Alarm setpoints

Number of setpoints	0, 1 or 2
Setpoint adjustment	-1999 to 1999.
Hysteresis adjustment	1 - 1999.
Time delay adjustment	0 - 99 s.
Alarm type	High or low, programmable.
Relay status	“Normally energized” or “Normally de-energized relay coil, programmable.

Diagnostics

Ovrange	EE
Underrange	-EE

7.2 Module Specifications & Scaling Values

In this chapter the specifications and the scaling values (input modules only) are described for each module. The scaling values inform how the decimal point, the high/low electrical inputs and the high/low display values have to be programmed to obtain a 1:1 relationship between input and display.

All input modules have the programming lock option. By interconnecting the two terminals marked "PROG LOCK" it is still possible to see the programmed parameters, but access to the programmed parameters will be disabled. If attempting to change parameters, the panel meter will lock for approx. 3 minutes and then restart.

Where the standard ordering number for an input module is 510053x the ordering number for the module with the programming lock option is 510063x. The modules are described as follows:

Input Modules

7.2.1	DC Voltmeter	(5100x30)
7.2.2	AC Voltmeter	(5100x31)
7.2.3	DC Ammeter	(5100x32)
7.2.4	AC Ammeter	(5100x33)
7.2.5	10 A AC/DC Ammeter	(5100x34)
7.2.6	Ohmmeter	(5100x35)
7.2.7	Pt 100	(5100x36)
7.2.8	Pt 100 850°C	(5100x39)
7.2.9	Thermocouple Type J	(5100x37)
7.2.10	Thermocouple Type K	(5100x38)
7.2.11	Frequency meter	(5100x41)
7.2.12	Tachometer	(5100x40)
7.2.13	Dupline® Analink Interface (G 2139 1139)	

Output Modules

7.2.14	Excitation output	(5100526)
7.2.15	Analog output	(5100560)
7.2.16	Relay output	(5100561 - 5100562)

Power Supply Modules

7.2.17	AC and DC	(5100520 - 5100524)
--------	-----------	---------------------

All specifications are measured at 23°C ambient temperature and rated operational supply voltage.

Accuracy mentioned in the tables means $\pm X\%$ of reading $\pm Y$ digits.

7.2.1 DC Voltmeter (5100530 and 5100630)

Specifications

Code (EDM)	Range	Resolution	Accuracy	Temperature drift	Input resistance	Max. overload (≤ 1 min.)
V1D	±199.9 mV	0.1 mV	0.2% ± 2 dgt	±100 ppm/°C ±0.05 dgt/°C	100 kΩ	50 V
V2D	±1.999 V	1 mV				230 V
V3D	±19.99 V	10 mV			1 MΩ	690 V
V4D	±199.9 V	0.1 V				
V5D	±600 V *	1 V				

Scaling Values

Code (EDM)	Range	DP	HiE	LoE	Hi	Lo
V1D	±199.9 mV	111.1	199.9	-199.9	199.9	-199.9
V2D	±1.999 V	1.111	1.999	-1.999	1.999	-1.999
V3D	±19.99 V	11.11	19.99	-19.99	19.99	-19.99
V4D	±199.9 V	111.1	199.9	-199.9	199.9	-199.9
V5D	±600 V *	1111	1999	-1999	690	-690

V5D is the default range set from factory.

* Nominal voltage according to IEC 664-1. The measuring range includes 15% tolerance equal to ± 690 VDC.

7.2.2 AC Voltmeter (5100531 and 5100631)

Specifications (40 Hz - 1 kHz)

Code (EDM)	Range	Resolution	Accuracy	Temperature drift	Input resistance	Max. overload (≤ 1 min.)
V1A	199.9 mV	0.1 mV	0.3% ± 3 dgt	±150 ppm/°C ±0.2 dgt/°C	100 kΩ	50 V
V2A	1.999 V	1 mV				230 V
V3A	19.99 V	10 mV			1 MΩ	690 V
V4A	199.9 V	0.1 V				
V5A	600 V *	1 V				

Scaling Values

Code (EDM)	Range	DP	HiE	LoE	Hi	Lo
V1A	199.9 mV	111.1	199.9	-0.1	199.9	-0.1
V2A	1.999 V	1.111	1.999	-0.001	1.999	-0.001
V3A	19.99 V	11.11	19.99	-0.01	19.99	-0.01
V4A	199.9 V	111.1	199.9	-0.1	199.9	-0.1
V5A	600 V *	1111	1999	-3	690	-1

V5A is the default range set from factory.

* Nominal voltage according to IEC 664-1. The measuring range includes 15% tolerance equal to 690 VAC.

7.2.3 DC Ammeter (5100532 and 5100632)

Specifications

Code (EDM)	Range	Resolution	Accuracy	Temperature drift	Voltage drop	Max. overload (≤ 10 s)
A1D	±199.9 µA	0.1 µA	0.2% ± 2 dgt	±100 ppm/°C ±0.05 dgt/°C	< 200 mV	20 mA
A2D	±1.999 mA	1 µA				100 mA
A3D	±19.99 mA	10 µA				200 mA
A4D	±199.9 mA	0.1 mA		500 mA		
A5D	±1999 mA	1 mA		4 A		
A6D	±5.00 A	10 mA		8 A		

Scaling Values

Code (EDM)	Range	DP	HiE	LoE	Hi	Lo
A1D	±199.9 µA	111.1	199.9	-199.9	199.9	-199.9
A2D	±1.999 mA	1.111	1.999	-1.999	1.999	-1.999
A3D	±19.99 mA	11.11	19.99	-19.99	19.99	-19.99
A4D	±199.9 mA	111.1	199.9	-199.9	199.9	-199.9
A5D	±1999 mA	1111	1999	-1999	1999	-1999
A6D	±5 A	11.11	19.99	-19.99	5.00	-5.00

A6D is the default range set from factory.

7.2.4 AC Ammeter (5100533 and 5100633)

Specifications

Code (EDM)	Range	Resolution	Accuracy	Temperature drift	Voltage drop	Max. overload (≤ 10 s)
A1A	199.9 µA	0.1 µA	0.3% ± 3 dgt	±150 ppm/°C ±0.5 dgt/°C	< 200 mV	20 mA
A2A	1.999 mA	1 µA				100 mA
A3A	19.99 mA	10 µA				200 mA
A4A	199.9 mA	0.1 mA		500 mA		
A5A	1999 mA	1 mA	4 A			
A6A	5.00 A	10 mA	0.5% ± 3 dgt	±200 ppm/°C ±0.5 dgt/°C		8 A

Scaling Values

Code (EDM)	Range	DP	HiE	LoE	Hi	Lo
A1A	199.9 µA	111.1	199.9	-0.1	199.9	-0.1
A2A	1.999 mA	1.111	1.999	-0.001	1.999	-0.001
A3A	19.99 mA	11.11	19.99	-0.01	19.99	-0.01
A4A	199.9 mA	111.1	199.9	-0.1	199.9	-0.1
A5A	1999 mA	1111	1999	-1	1999	-1
A6A	5 A	11.11	19.99	-0.04	5.00	-0.01

A6A is the default range set from factory.

7.2.5 10 A AC/DC Ammeter (5100534 and 5100634)

Specifications

Code (EDM)	Range	Resolution	Accuracy	Temperature drift	Voltage drop	Max. overload (≤ 10 s)
A7A	10 A AC	10 mA	0.5% ± 5 dgt	±200 ppm/°C ±0.5 dgt/°C	< 200 mV	12 A
A7D	±10 A DC		0.5% ± 5 dgt	±200 ppm/°C ±0.1 dgt/°C		

Scaling Values

Code (EDM)	Range	DP	HiE	LoE	Hi	Lo
A7A	10 A AC	11.11	19.99	-0.2	10	-0.01
A7D	±10 A DC			-19.99		-10.00

A7A is the default range set from factory.

7.2.6 Ohmmeter (5100535 and 5100635)

Specifications

Code (EDM)	Range	Resolution	Accuracy	Temperature drift	Open circuit voltage	Excitation current
R1D	199.9 Ω	0.1 Ω	0.2% ± 2 dgt	±150 ppm/°C ±0.1 dgt/°C	6 VDC	1 mA
R2D	1.999 kΩ	1 Ω				100 μA
R3D	19.99 kΩ	0.01 kΩ				10 μA
R4D	199.9 kΩ	0.1 kΩ				1 μA

Scaling Values

Code (EDM)	Range	DP	HiE	LoE	Hi	Lo
R1D	199.9 Ω	111.1	199.9	-0.1	199.9	-0.1
R2D	1.999 kΩ	1.111	1.999	-0.001	1.999	-0.001
R3D	19.99 kΩ	11.11	19.99	-0.01	19.99	-0.01
R4D	199.9 kΩ	111.1	199.9	-0.1	199.9	-0.1

R1D is the default range set from factory.

7.2.7 Pt 100 Thermometer (5100536 and 5100636)

Specifications

Code (EDM)	Sensor type	Range	Resolution	Accuracy	Temperature drift
P1C	RTD Pt 100 α = 0.00385	-100.0 to 199.9°C	0.1°C	0.2% of rdg ±2 dgt	±150 ppm/°C ±0.05 count/°C
P1F		-148.0 to 199.9°F	0.2°F	0.4% of rdg ±4 dgt	±180 ppm/°F ±0.1 count/°F
P2F		-148.0 to 392°F	1°F	0.2% of rdg ±4 dgt	

7.2.7 Pt 100 Thermometer (5100536 and 5100636) - continued

Scaling Values

Code (EDM)	Range	DP	HiE	LoE	Hi	Lo
P1C	-100.0 to 199.9°C	111.1	199.9	-100.0	199.9	-100.0
P1F	-148.0 to 199.9°F		93.2			-148.0
P2F	-148.0 to 392°F	1111	1999	-100	392	-148

P1C is the default range set from factory.

7.2.8 Pt 100 850°C Thermometer (5100539 and 5100639)

Specifications

Code (EDM)	Sensor type	Range	Resolution	Accuracy	Temperature drift
P2C	RTD Pt 100 α = 0.00385	-100 to 850°C	1°C	0.2% of rdg ±3 dgt	±150 ppm/°C ±0.05 count/°C
P3F		-148 to 1562°F	2°F	0.4% of rdg ±6 dgt	±180 ppm/°F ±0.1 count/°F

Scaling Values

Code (EDM)	Range	DP	HiE	LoE	Hi	Lo
P2C	-100 to 850°C	1111	1999	-235	850	-100
P3F	-148 to 1562°F				1562	-148

P2C is the default range set from factory.

7.2.9 Thermocouple Type J Thermometer (5100537 and 5100637)

Specifications

Code (EDM)	Sensor type	Range	Resolution	Accuracy	Temperature drift
-JC	Thermocouple Type J	-100 to 760°C	1°C	0.1% of rdg ±4 dgt	±100 ppm/°C ±0.05 count/°C
-JF		-148 to 1400°F	2°F	0.1% of rdg ±8 dgt	±180 ppm/°F ±0.1 count/°F

Scaling Values

Code (EDM)	Range	DP	HiE	LoE	Hi	Lo
-JC	-100 to 760°C	1111	1999	-264	760	-100
-JF	-148 to 1400°F				1400	-148

-JC is the default range set from factory.

7.2.10 Thermocouple Type K Thermometer (5100538 and 5100638)

Specifications

Code (EDM)	Sensor type	Range	Resolution	Accuracy	Temperature drift
-KC	Thermocouple Type K	-100 to 1250°C	1°C	3% of rdg ±3 dgt	±100 ppm/°C ±0.05 count/°C
-KF		-148 to 1999°F	2°F	4% of rdg ±5 dgt	±180 ppm/°F ±0.1 count/°F

Scaling Values

Code (EDM)	Range	DP	HiE	LoE	Hi	Lo
-KC	-100 to 1250°C	1111	1999	-160	1250	-100
-KF	-148 to 1999°F		1748		1999	-148

-KC is the default range set from factory.

Accuracy for Sub-ranges

Code (EDM)	Sensor type	Range	Resolution	Accuracy	Temperature drift
-KC	Thermocouple Type K	-100 to -50°C	1°C	1% of rdg +5/-1 dgt	±100 ppm/°C ±0.05 count/°C
		-50 to 780°C		0.1% of rdg ±3 dgt	
		780 to 1250°C		0.25% of rdg +1/-3 dgt	
-KF	Thermocouple Type K	-148 to -58°F	2°F	1% of rdg +10/-2 dgt	±180 ppm/°F ±0.1 count/°F
		-58 to 1436°F		0.1% of rdg ±5 dgt	
		1436 to 1999°F		0.25% of rdg +2/-6 dgt	

7.2.11 Frequency Meter (5100541 and 5100 641)

Specifications

Code (EDM)	Range	Resolution	Accuracy	Temperature drift	Input	Input imp.
F1x	5.0 to 199.9 Hz	0.1 Hz	1% of reading ±5 dgt	± 200 ppm/°C	Namur	1 kΩ
F2x	10 to 1999 Hz	1 Hz			NPN, PNP, contact 600 VAC	5 kΩ 600 kΩ

Scaling Values

Code (EDM)	Range	DP	HiE	LoE	Hi	Lo
F1x	5.0 to 199.9 Hz	111.1	199.9	5.0	199.9	5.0
F2x	10 to 1999 Hz	1111	1999	10	1999	10

F2B is the default range set from factory.

Connections: Namur: Vout sensor (+), IMP INPUT (-)
NPN, PNP, Contact: IMP INPUT and IN LO
AC voltages: 600 VAC and IN LO

7.2.12 Tachometer (5100540 and 5100 640)

Specifications

Code (EDM)	Range	Resolution	Accuracy	Temperature drift	Input/Input impedance		
T1A	8.0 to 199.9 rpm, 30 ppr	0.1 rpm	1% of reading ±5 dgt	± 200 ppm/°C	Namur / 1 kΩ		
T1B	8.0 to 199.9 rpm, 30 ppr				NPN, PNP, contact / 5 kΩ		
T2A	5.0 to 199.9 rpm, 60 ppr				Namur / 1 kΩ		
T2B	5.0 to 199.9 rpm, 60 ppr				NPN, PNP, contact / 5 kΩ		
T3A	3.0 to 199.9 rpm, 100 ppr				Namur / 1 kΩ		
T3B	3.0 to 199.9 rpm, 100 ppr				NPN, PNP, contact / 5 kΩ		
T4A	20 to 1999 rpm, 30 ppr	1 rpm					Namur / 1 kΩ
T4B	20 to 1999 rpm, 30 ppr				NPN, PNP, contact / 5 kΩ		
T5A	10 to 1999 rpm, 60 ppr				Namur / 1 kΩ		
T5B	10 to 1999 rpm, 60 ppr				NPN, PNP, contact / 5 kΩ		
T6A	10 to 1999 rpm, 100 ppr				Namur / 1 kΩ		
T6B	10 to 1999 rpm, 100 ppr				NPN, PNP, contact / 5 kΩ		

Scaling Values

Code (EDM)	Range	DP	HiE	LoE	Hi	Lo
T1x	8.0 to 199.9 rpm, 30 ppr	111.1	199.9	8.0	199.9	8.0
T2x	5.0 to 199.9 rpm, 60 ppr	111.1	199.9	5.0	199.9	5.0
T3x	2.0 to 199.9 rpm, 100 ppr	111.1	199.9	2.0	199.9	2.0
T4x	20 to 1999 rpm, 30 ppr	1111	1999	20	1999	20
T5x	10 to 1999 rpm, 60 ppr	1111	1999	10	1999	10
T6x	10 to 1999 rpm, 100 ppr	1111	1999	10	1999	10

T6B is the default range set from factory.

Connections: Namur: Vout Namur (+), IMP INPUT (-)
NPN, PNP, Contact: IMP INPUT, Vout NPN/PNP and IN LO

7.2.13 Dupline® Analink Interface Module (G 2139 1139)

Scaling Values

Code (EDM)	DP	HiE	LoE	Hi	Lo
-	111.1	1999	0	60.0 [°C]	-30.0 [°C]

The values shown are factory settings. **The scaling values can be changed according to the used Dupline® Analink transmitter**

7.2.14 Excitation Output Module (5100526)

Specifications

Output voltage	Max. allowable output current	Short-circuit protection
12 VDC ± 20%	35 mA	Yes
24 VDC ± 20%	20 mA	

7.2.15 Analogue Output Module (5100560)

Specifications

Output range	Accuracy	Temperature drift	Load resistance	Output resistance	Short-circuit protection	Time constant
0 - 20 mA	±1% ±0.1 mA	±200 ppm/°C	< 500 Ω	N/A	Yes	1 s
4 - 20 mA			> 1000 Ω	≤ 3 Ω		
0 - 10 V	±1% ±0.05 V					

Outputs are source signals and linearly proportional to the displayed values.

A) 0 - 20 mADC and 4 - 20 mADC output signal

Relationship between output signal and displayed value:

$$\begin{array}{ll}
 \mathbf{0 - 20\ mA} & \mathbf{4 - 20\ mA} \\
 I = \frac{20 (Rdg - Lo)}{Hi - Lo} & I = \frac{16 (Rdg - Lo)}{Hi - Lo} + 4
 \end{array}$$

- I** = output current (mA)
- Hi** = max. programmed value of the whole measuring range
- Lo** = min. programmed value of the whole measuring range
- Rdg** = displayed value

B) 0 - 10 V output signals

Relationship between output signal and displayed value:

$$V = \frac{10 (Rdg - Lo)}{Hi - Lo}$$

- V** = output voltage (V)
- Hi** = max. programmed value of the whole measuring range
- Lo** = min. programmed value of the whole measuring range
- Rdg** = displayed value

Relationship between over-/underrange and analogue output:

Input signal to EDM	Display indication	Analogue output 0 - 20 mA	Analogue Output 4 - 20 mA	Analogue Output 0 - 10 V
> HiE (overrange)	EE	20 mA	20 mA	10 V
< LoE (underrange)	-EE	0 mA	4 mA	0 V

Caution!

An insulation voltage of 125 Vrms between analogue output and all other connections, except relay outputs and power supply, limits the use of the system. The insulation voltage is only intended to break ground loops and not to serve as a safety function.

7.2.16 Relay Output Modules (5100561 and 5100562)

Specifications

Module number	SPDT contacts	Rated Insulation voltage	AC1 load	DC1 load	AC15 load	DC13 load	Min. load	Dielectric voltage	Update frequency
5100561	1	250 V Basic	5 A 250 VAC	5 A 24 VDC	2 A 250 VAC	3 A 24 VDC	0.1 A 24 V	2 kV AC (RMS)	2 Hz
5100562	2								

7.2.17 Power Supply Modules AC and DC (5100520 to 5100524)

Specifications

Module number	Input voltage	Rated oper. power	“Hold” input
5100520	230 VAC ± 10%	6 VA	Yes
5100521	115 VAC ± 10%		
5100522	48 VAC ± 10%		
5100523	24 VAC ± 10%		
5100524	12 - 48 VDC ± 15%	6 W	

7.3 Mechanical Dimensions

Below are shown the mechanical dimensions of the panel meter, the maximum allowable thickness of the panel and the panel cutout. All dimensions are in [mm].

Front view

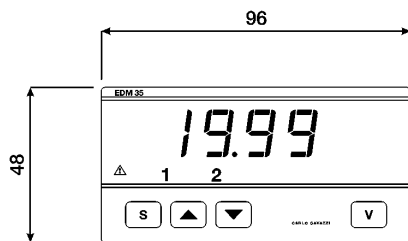

Side view

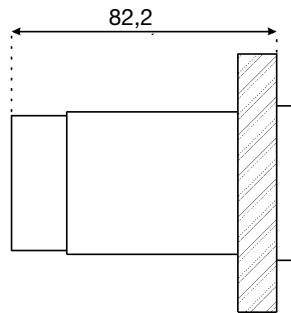

Top view

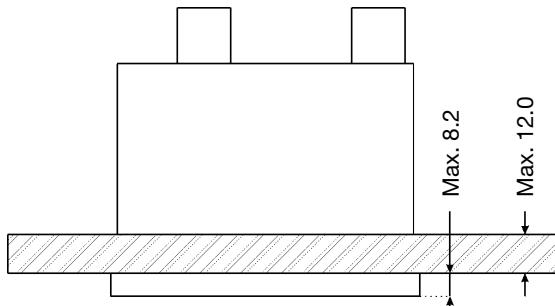

Panel cutout

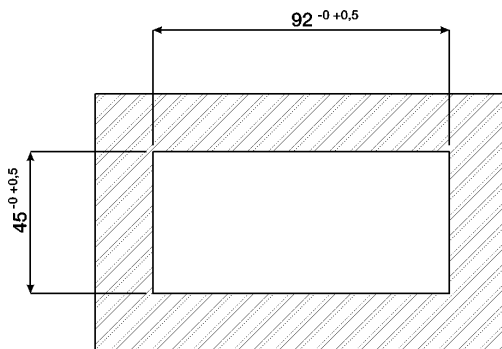

8 Appendix

8.1 Reset of Password

The programming access password is factory set to '0'. For returning the password to '0' you have to use the predefined password '99' in the procedure described below.

1. Press **S** and **▼** simultaneously at Power ON until the display shows **PAS**. Release the keys. The display shows **PAS** for 2 s.
2. Press **▲** or **▼**, until the '99' password is displayed - then the instrument shows **rES**.
3. Press **S** to reset the password or turn off the EDM to exit without any changes.

8.2 Quick Reference Guide

Programming

Mnemonic (shown 2 s)	Programming Function	Display (examples)
<code>PAS</code>	Password control. New password	<code>0</code>
<code>dP</code>	Decimal point selection	<code>1.111</code>
<code>HiE</code>	High limit for electrical input range	<code>1999</code>
<code>LoE</code>	Low limit for electrical input range	<code>-9999</code>
<code>Hi</code>	Display span, value corresponding to HiE	<code>1999</code>
<code>Lo</code>	Display span, value corresponding to LoE	<code>-9999</code>
<code>SP1</code>	Setpoint 1	<code>1000</code>
<code>HYS</code>	Hysteresis (setpoint 1)	<code>0001</code>
<code>dEL</code>	Time delay in seconds (setpoint 1)	<code>1</code>
<code>uP</code> <code>do</code>	High or low alarm level (setpoint 1)	<code>uP</code> <code>do</code>
<code>nd</code> <code>nd</code>	Normally energized or de-energized relay	<code>nd</code> <code>nd</code>
<code>On</code> <code>OFF</code>	Relay on or off in overflow condition	<code>On</code> <code>OFF</code>
<code>SP2</code>	Setpoint 2 parameters as setpoint 1	
<code>End</code>	End of programming	

Enter programming mode: Press `S` and `▲` simultaneously.

Change parameters: Press `▲` and/or `▼`.

Step to next parameter: Press `S`.

Commands & Passwords

Setpoint 1 value Press  .

Setpoint 2 value Press  .

Peak & Valley values Press  and  simultaneously.

Reset Peak & Valley Press  ,  and  simultaneously.

Programming Mode Press  and  .

Calibration Mode Press  and  during power-up.

Change Parameters Press  and/or  .

Next Parameter Press  .

Passwords	Valid passwords	0 - 199
	Setpoint access only	100 - 199

Passwords	Input range selection	66
	Reset password	99

