

Miniature Relays Series M

Type MZ 1 pole 10A

Monostable



- Miniature size
- PCB mounting
- Reinforced insulation 4 kV / 8 mm
- Switching capacity 10 A
- DC coils 1.87 to 160 VDC
- AC coils 4.8 to 264 VAC
- General purpose, industrial electronics
- Types: Standard, flux-free or sealed
- Switching AC/DC load

Product Description

Sealing

P: Standard, suitable for soldering and manual washing.
F: Flux-free, suitable for automatic soldering and partial immersion or spray washing.

H: Sealed with according to IP 67, suitable for automatic soldering and/or partial immersion or spray washing.

Ordering Key

MZ P A 100 47 10

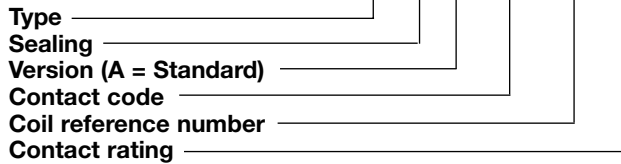

Version

A = 3.5 mm / Ag CdO (standard);
 B = 5.0 mm / Ag CdO
 C = 3.5 mm / hard gold plated
 D = 3.5 mm / flash gilded
 S = 3.5 mm / Ag Sn O₂
 T = 5.0 mm / Ag Sn O₂
 Available only on request Ag Ni

For General data, notes and special versions see page 48

Type Selection

Contact configuration	Contact rating	Contact code
1 normally open contact (SPST -NO {1-form A})	10 A	100
1 change over contact (SPDT {1-form C})	10 A	001

Coil Characteristics DC (20°C)

Coil ref. no.	Rated Voltage VDC	Winding resistance		Operating range		Must release VDC
		Ω	± %	min VDC	Max. VDC	
40	2.5	11	10	1.87	3.50	≥ 5% of rated voltage
41	4.1	30	10	3.13	5.75	
42	5.6	55	10	4.28	7.80	
43	8.0	110	10	6.14	11.00	
44	10.0	170	10	7.56	13.70	
45	12.5	280	10	9.49	17.60	
46	16.0	450	10	12.30	22.50	
47	20.5	720	15	15.50	28.60	
48	22.5	860	15	17.10	30.80	
49	26.0	1150	15	19.70	35.70	
50	32.5	1750	15	24.90	44.00	
51	40.5	2700	15	30.90	55.00	
52	51.5	4300	15	39.60	69.30	
53	64.5	6450	15	49.20	84.70	
54	83.0	9900	15	63.60	104.00	
55	95.0	12550	15	73.00	117.00	
56	109.0	16200	15	83.30	136.00	
57	125.0	23500	15	96.00	160.00	



Miniature Relays Series M
Type MZ 1 pole 10A
Monostable



Coil Characteristics AC (20°C)

Coil ref. no.	Rated Voltage VAC	Winding resistance Ω	resistance ± %	Operating range		Must release VAC	Rated Current (mA)		Inductance H
				min VAC	Max. VAC		50Hz	60Hz	
90	6	12	10	4.8	6.6	≥ 15% of rated voltage	270.0	237.0	0.059
91	12	56	10	9.6	13.2		119.0	104.0	0.267
92	24	230	10	19.2	26.4		57.0	50.0	1.123
93	48	870	15	38.4	52.8		30.5	26.7	4.170
94	60	1500	15	48.0	66.0		23.8	21.0	6.450
95	110	5300	15	88.0	129.0		12.3	10.8	22.400
96	220	20000	15	176.0	242.0		5.9	5.2	100.200
97	240	25000	15	192.0	264.0	5.7	5.0	107.800	

Contact Characteristics

Rating	10 A	Power Max. switching power with resistive load in AC ³⁾ Max. switching power in DC Minimum switching current ²⁾ (Typical value)	2500 VA see diagram 3 100mA at 24VDC
Material (standard version) ²⁾	AgCdO		
Current (at 250VAC) Rated current Max. switching current Overload current (4sec ON/40sec OFF cycle)	10 A 12 A 15 A	Life (see diagram 1) Typical electrical life at max. resistive load 1000 cycles/h 500 cycles/h Max. electrical repetition rate Mech. life at 18000 cycles/h	3 x 10⁵ cycles 3.5 x 10⁵ cycles 3600 cycles/h 50 x 10⁵ cycles
Voltage Rated voltage Max. switching voltage (VDE 0435)	250 VAC 380 VAC		

²⁾³⁾ See pag. 48

Dimensions

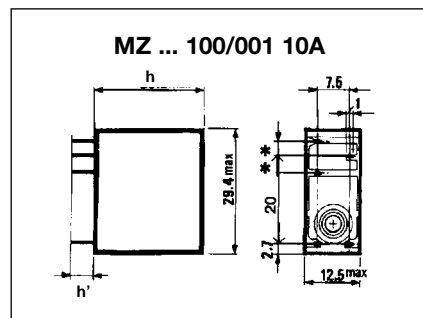

MZP: h = 25,2 mm
h' = 4,3 - 5,7 mm

MZF/MZH: h = 26,5 mm
h' = 2,8 - 4,2 mm

* 'A' Standard version = 3,5 mm
* 'B' Metric version = 5,0 mm

Pin View

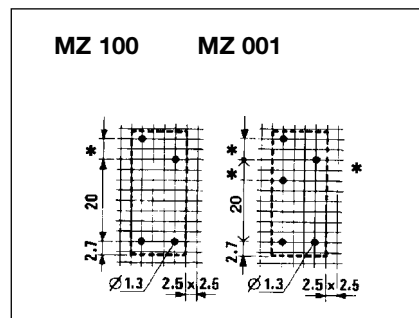

Wiring Diagrams

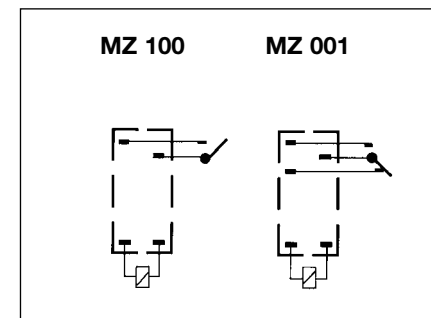

Diagrams

1 Expected life at 250 VAC
(Resistive loads and repetition rate 1000 cycles/h)

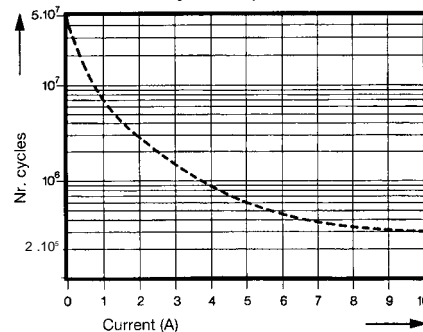

2 Reduction of expected life against load power factor cos φ

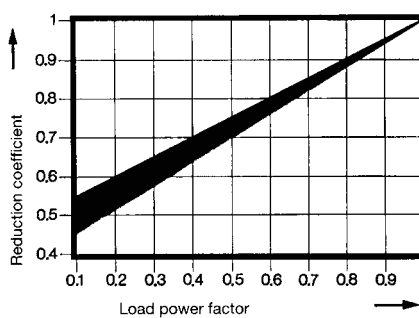

3 Max. switching power DC

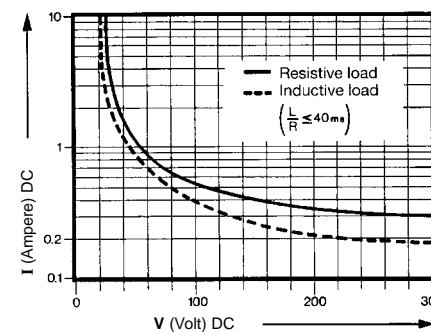

Specifications are subject to change without notice