

SunBright Solar Battery Charger

CARLO GAVAZZI



- 12VDC, 24VDC system voltage
- 6A, 10A, 20A and 30A battery current ratings
- 8 automatic charging programs (bulk, float, equal)
- Charge LED status
- Battery Temperature Sensor (BTS)
- Manual / Auto Equalization

Product Description

SunBright is a solar battery charger device with an advanced design using a microcontroller for digital accuracy and fully automatic operation. Each model unit can be used for 12V and 24V

system for solar battery charging. The PWM battery charging has been optimized for longer battery life.

Ordering Key

SBC 30A

Serie _____
Models _____

Approvals



Type Selection

Serie		Models	
SBC	Solar Battery Charger	6A 10A 20A 30A	6A Current rating battery charge 10A Current rating battery charge 20A Current rating battery charge 30A Current rating battery charge

Electrical Data

Model	SBC 6A	SBC 10A	SBC 20A	SBC 30A
System voltage ratings	12VDC	12, 24VDC		
Current ratings - Battery Charge Control	6A	10A	20A	30A
Accuracy	±60mV	12/24V: 0.1% ± 50mV		
Min. / Max operating voltage	6V/16V	9V/34V		
Max. solar array Voc	30V	50V		
Current consumption	6mA	9mA		
High temperature shutdown	N/A	90°C disconnect solar 70°C reconnect solar		

Battery Charging/Built-in BTS Data

Model	SBC 6A	SBC 10A	SBC 20A	SBC 30A
Charge algorithm	PWM (Pulse Width Modulation), constant voltage			
Temp comp. coefficient	-5mV/°C / cell (25°C ref)	12V: -5mV/°C / cell (25°C ref) 24V: -10mV/°C / cell (25°C ref)		
Temp comp. range	0°C to +50°C			
Temp comp. setpoints	PWM setpoint: 14.1V	PWM, float, equalize (with BTS)		

Environmental Data

Model	SBC 6A	SBC 10A	SBC 20A	SBC 30A
Ambient temperature	-40 to +45°C			
Storage temperature	-55 to +85°C			
Humidity	100% (Non Condensing)			
Enclosure	Indoor and vented (power coated steel)			

Mechanical Data

Model	SBC 6A	SBC 10A	SBC 20A	SBC 30A
Weight	0.2kg	0.3kg		0.4kg
Enclosure	Indoor & natural air convection, (powder coated steel)			
Optional remote panel	Not available			Optional LCD display

General Overview

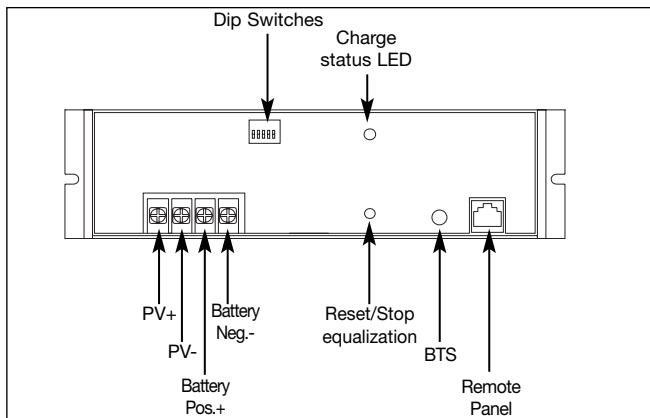

Minimum Clearance

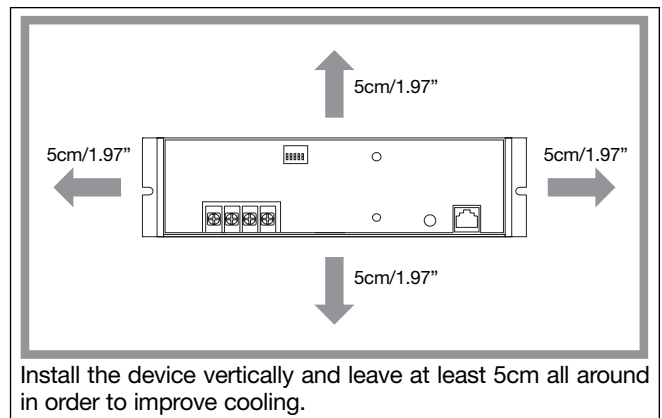

Wiring Diagram

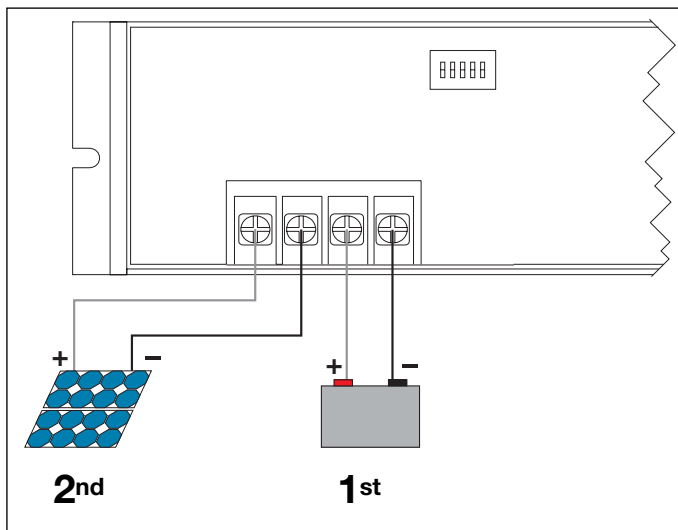

- 1st Connect the Battery
- 2nd Connect the Photovoltaic panel (PV array)

Note:

- The device prevents reverse current leakage at night, so a blocking diode is not required in the system.
- The terminals will accept a maximum wire size of AWG#10 (up to 5.2mm²). (Some #10 spade connectors may not fit in this terminal.)
- Tighten each terminal screw maximum to 2.26Nm (20inch-pounds) of torque.
- It is designed to regulate power from a PV array. However other generators can be connected directly to the battery, with no effect on this device.
- A battery below 10V may not start the microcontroller properly. Make sure the battery is charged before installing the system.
- Reverse polarity: verify the polarity (+ and -) before applying power.

Dimensions (mm)

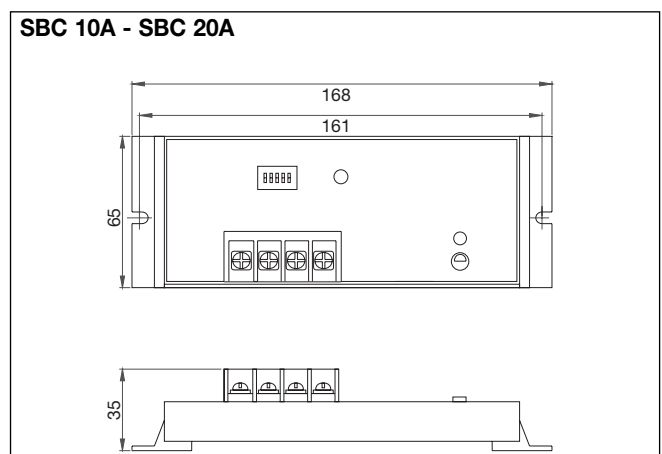
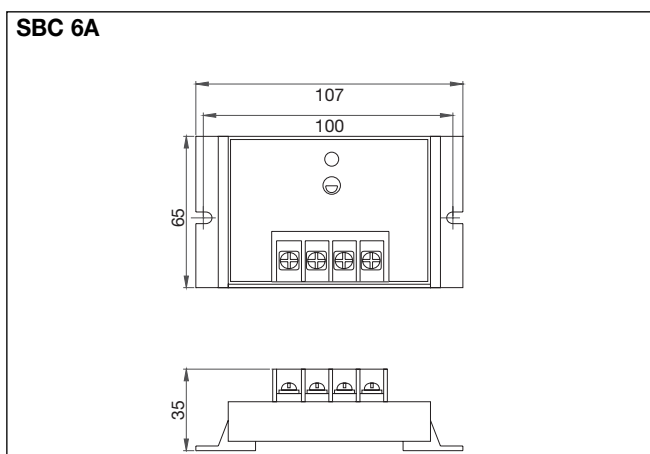

Dimensions (mm)

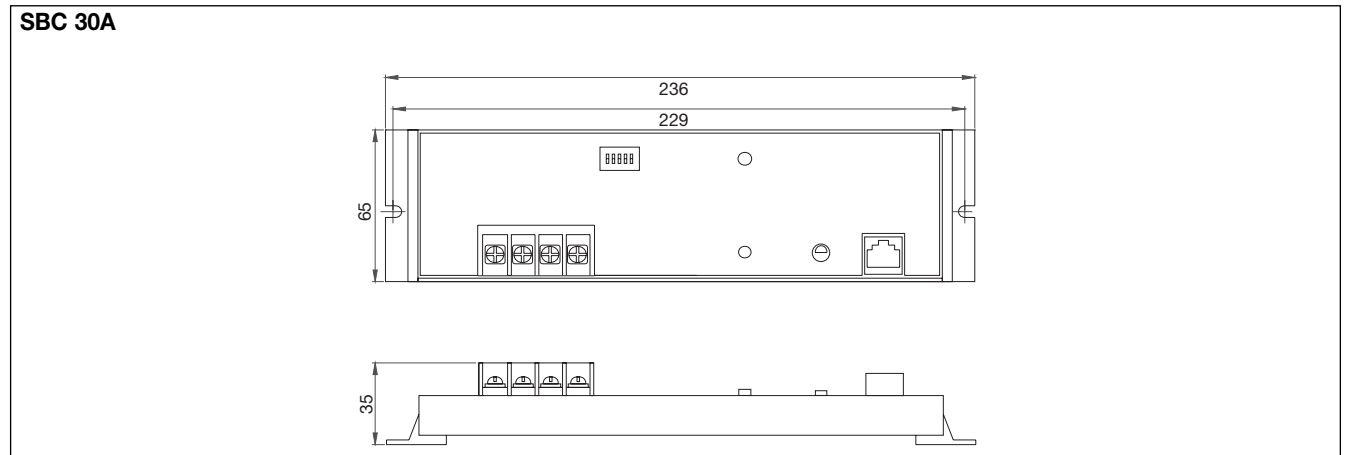



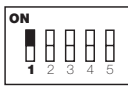
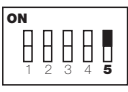

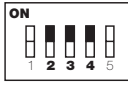
DIP Switch

	Battery Voltage		Equalization
1		5	
ON		OFF	
OFF	24V system	ON	Auto Equalization

			Battery Charging Programs					
			Battery	Bulk	Float	Equalize	Equalize time	Equalize Interval
2	3	4	Type	Voltage	Voltage	Voltage	(Hours)	(Days)
OFF	OFF	OFF	1-Sealed	14.0	13.4	None	-	-
OFF	OFF	ON	2-Sealed	14.1	13.4	14.2	1	28
OFF	ON	OFF	3-Sealed	14.3	13.4	14.4	2	28
OFF	ON	ON	4-Flooded	14.4	13.4	15.1	3	28
ON	OFF	OFF	5-Flooded	14.6	13.4	15.3	3	28
ON	OFF	ON	6-Flooded	14.8	13.4	15.3	3	28
ON	ON	OFF	7-L-16	15.0	13.4	15.3	3	14
ON	ON	ON	8-NiCad	16.0	14.5	None	-	-

LED status

Charge Status LED		Blinking Green: Charging is in the state of Bulk or Absorption.
		Fixed Green: Charging is in the state of Float.
		Fixed Orange: Charging in the state of Equalization.
		Fixed Red: Charging in the state of fault: Over Current.
		Blinking Red: Charging in the state of fault: Over Temp.

Reset/Stop Equalization

MANUAL
EQU/LVR



PUSH RESET/STOP EQUQUALIZATION

When a fault occurs, push Manual Equalize/LVR to reset it.

HOLD RESET/STOP EQUQUALIZATION

Battery charge control mode: Hold Reset/Stop Equalization to manually start equalization and press it again to stop equalization.

Battery Temperature Sensor (BTS)

BTS



A sensor next to the remote panel is used for temperature compensated battery charging.

As the battery gets warmer, the gassing increases. As the battery gets colder, it becomes more resistant to charging. Depending on how much the battery temperature varies, it may be important to adjust the charging for temperature changes.

Features

Solar Overload

Enhanced radiation or “edge of cloud effect” conditions can generate more current than the controller’s rating. The device will reduce this overload up to 130% of rated current by regulating the current to safe level. If the current from the solar array exceeds 150%, the controller will stop charging.

Battery Temperature Compensation

All charging setpoints are based on 25°C (77°F). If the battery temperature varies by 5°C, the charging will change by 0.15 volts for a 12 volt battery. This is a substantial change in the charger of the battery.