

Photoelectrics

Laser, Diffuse-reflective (Colour Mark Sensor)

Type LD32CND15

CARLO GAVAZZI



- Miniature sensor range
- Range: 150 mm
- Sensitivity adjustment by Teach-In programming
- Modulated, red laser light 650 nm (class 2)
- Supply voltage: 10 to 30 VDC
- Output: 100 mA, NPN or PNP preset
- Make and break switching function programmable
- LED for output indication, signal stability and power ON
- Protection: reverse polarity, short circuit and transients
- Cable and plug versions
- Compact housing
- Excellent EMC performance
- Accurate detection of small printing marks

Product Description

The LD32CND15 sensor family comes in a compact 12 x 32 x 20 mm reinforced PMMA/ABS-housing. The sensors are useful in applications where high-accuracy detection as well as small size is required. The Teach-In function for

adjustment of the sensitivity makes the sensors highly flexible. The output type is preset (NPN or PNP), and the output switching function is programmable (NO or NC). The small laser spot makes the diffuse-reflective sensor useful as colour mark sensor.

Ordering Key

LD32CND15PPM5T

Type	_____
Housing style	_____
Housing size	_____
Housing material	_____
Housing length	_____
Detection principle	_____
Sensing distance	_____
Output type	_____
Output configuration	_____
Connection type	_____
Teach-In	_____

Type Selection

Housing W x H x D	Range S _n	Ordering no. NPN & PNP cable Make & break switching	Ordering no. NPN & PNP plug Make & break switching
12 x 32 x 20 mm	150 mm	LD 32 CND 15 NPT LD 32 CND 15 PPT	LD 32 CND 15 NPM5T LD 32 CND 15 PPM5T

Specifications

Rated operating distance (S_n)	Up to 150 mm, reference target Kodak test card R 27, white, 90% reflectivity, 100 x 100 mm Optimal working distance as colour mark sensor is 70-100 mm.	Minimum operational current (I_m)	0.5 mA
Blind zone	None	OFF-state current (I_r)	≤ 100 μA
Sensitivity	Adjustable by Teach-In (push button or wire)	Voltage drop (U_d)	≤ 2.4 VDC @ 100 mA
Temperature drift	≤ 1%/°C	Protection	Short-circuit, reverse polarity and transients
Hysteresis (H) (differential travel)	≤ 10%	Laser protection class	Class 2 - according to EN60825-1-3/97
Rated operational volt. (U_B)	10 to 30 VDC (ripple included)	Average power	< 1 mW
Ripple (U_{rpp})	≤ 10%	Pulse width	t = 3 μs
Output current		Pulse repetition time	f = 5 kHz
Continuous (I _a)	≤ 100 mA	MTBF	> 50'000 h @ T _a = 40°C
Short-time (I)	≤ 100 mA (max. load capacity 100 nF)	Light source	Laser, red light, 650 nm
No load supply current (I_o)	≤ 25 mA @ 24 VDC	Light type	red, modulated
		Sensing angle	< 0.8°
		Ambient light	5,000 lux
		Light spot	< 0.7 mm @ focus
		Operating frequency	1000 Hz
		Response time	
		OFF-ON (t _{ON})	≤ 0.5 ms
		ON-OFF (t _{OFF})	≤ 0.5 ms
		Power ON delay (t_v)	≤ 300 ms

Specifications (cont.)

Output function NPN and PNP NO/NC switching function	Preset Set up by button	Vibration	10 to 55 Hz, 0.5 mm/7.5 g (IEC 60068-2-6)
External Teach (ET) Same function as button Locked (disable teach button) Operating mode	10 to 30 VDC 0 to 2.5 VDC Not connected	Shock	30 g/11 ms, 3 pos, 3 neg per axis (IEC 60068-2-6, 60068-2-32)
Indication Output ON Signal stability ON and power ON	LED, yellow LED, green	Rated insulation voltage	500 VAC (rms)
Environment Installation category Pollution degree Degree of protection	II (IEC 60664/60664A; 60947-1) 3 (IEC 60664/60664A; 60947-1) IP 67 (IEC 60529; 60947-1)	Housing material Body Front material	ABS, black PMMA, red
Ambient temperature Operating Storage	-20 to +60°C (-4 to +140°F) -20 to +80°C (-4 to +176°F)	Connection Cable Plug	PUR, black, 2 m 4 x 0.14 mm ² , Ø = 3.6 mm M8, 4-pin
		Weight	Cable type: 40 g Plug type: 10 g
		CE-marking	Yes

Operation Diagram

tv = Power ON delay

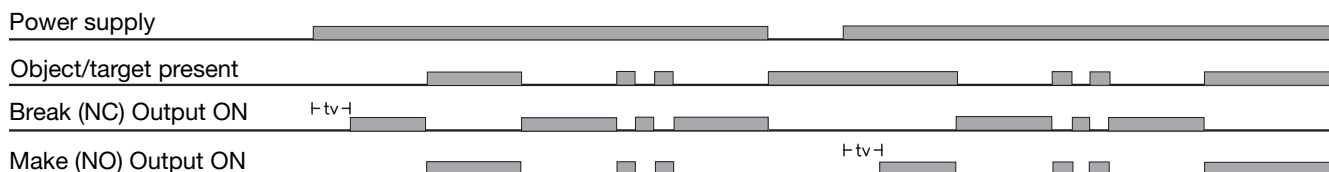

Wiring Diagrams

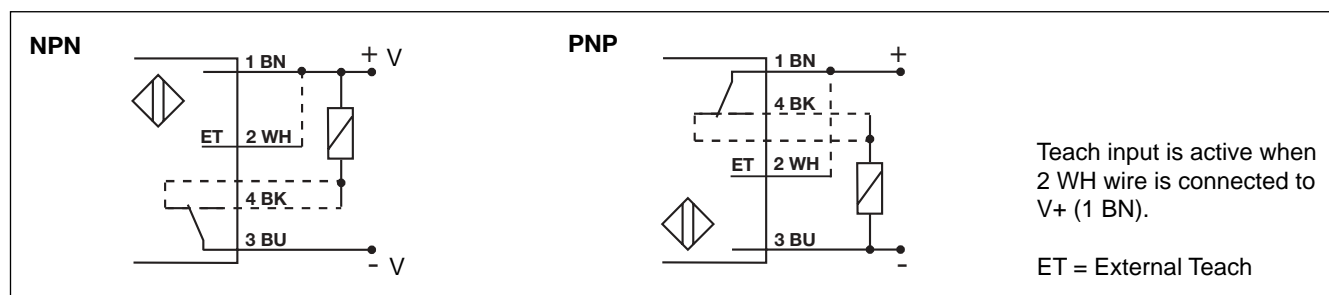

Installation Hints

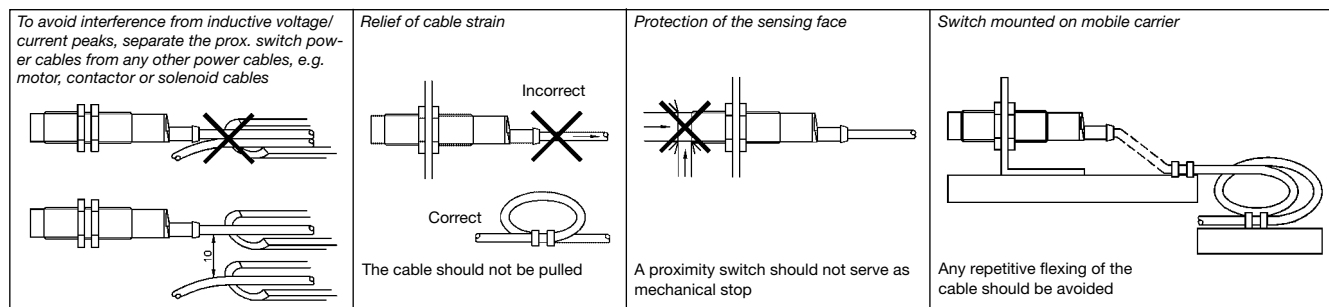

Dimensions

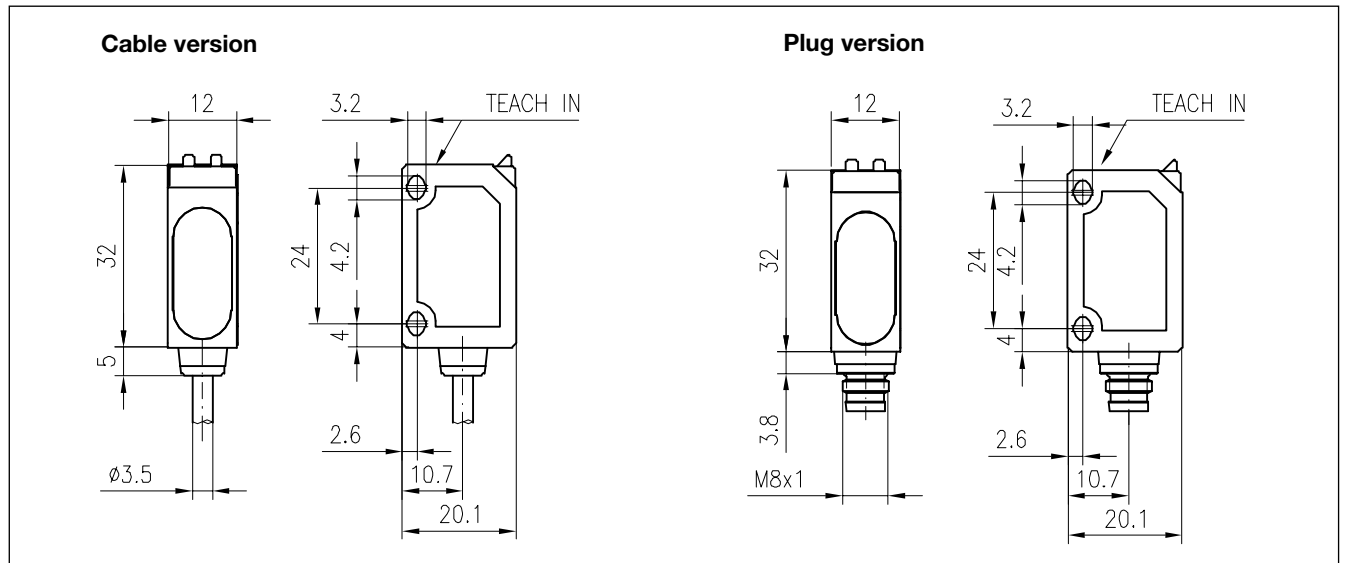

Signal Stability Indication

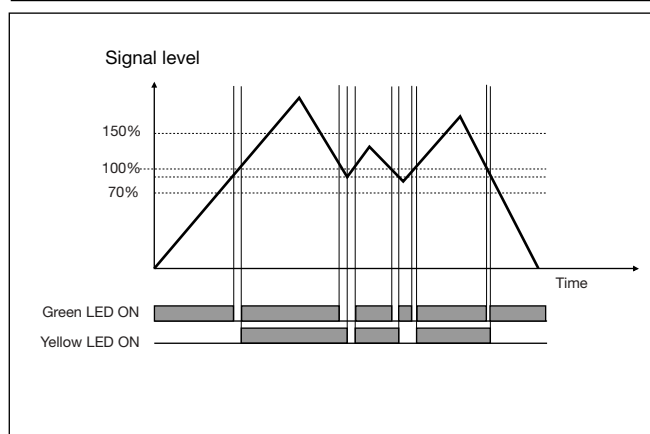

Accessories

Mounting bracket APD32-MB1

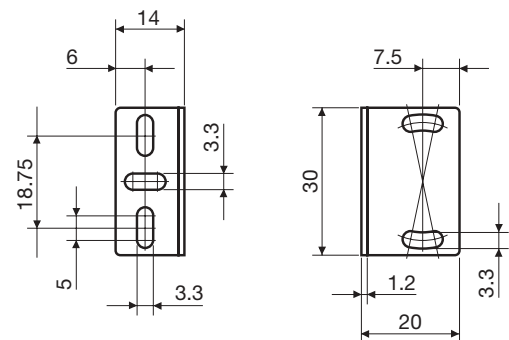

For further information refer to "Accessories"

Delivery Contents

- Photoelectric switch: LD 32 CND 15
- Installation instruction
- **Packaging:** Cardboard box

Adjustment

Sensitivity adjustment, with static object

1. Line up the sensor with the object. Yellow LED and green LED are ON.
2. Press the button for 3 s until both LED's flash simultaneously (the first switching point is stored).
3. Place the object outside the detection area.
4. Press the button for 1 s.
 - a) The green LED flashes and stays ON: the second switching point is stored, and the sensor is ready to operate.
 - b) Both LED's flash simultaneously: the sensor cannot detect the object, no switching points are stored.

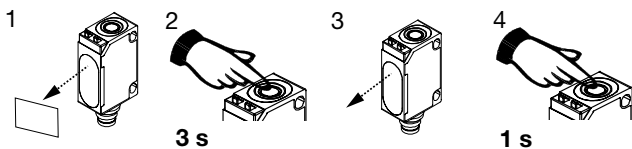



Sensitivity adjustment, with only one object

1. Line up the sensor with the object. Yellow LED and green LED are ON.
2. Press the button for 3 s until both LED's flash simultaneously (the first switching point is stored).
3. Leave the object in the detection area, press the button for 1 s. The green LED flashes and stays on: the second switching point is stored, and the sensor is ready to operate.

Sensitivity adjustment, with a running process

1. Line up the sensor with the object. Green LED is ON. At this stage the status of the yellow LED can be ignored.
2. The running process must be the only "object" within the detection area. Press the button for 3 s until both LED's flash simultaneously.

 **3 s**
3. Press the button for at least the duration of one process cycle.



 **1 cycle**

 - a) The green LED flashes and stays ON: both switching points have been stored, and the sensor is ready to operate.
 - b) Both LED's flash simultaneously: the sensor cannot detect the object, no switching points are stored.

Programming of make and break switching function

1. Press the button for 13 s.  **13 s**
Both LED's flash alternately.
2. Release the button: the green LED flashes.
3. While the green LED flashes, the output is inverted each time the button is pressed. This is indicated by the yellow LED.
When the button is not pressed for 10 s, the current output function is stored.
The sensor is now ready for operation.

Default setting

1. No object in the detection area: Press the button for 3 s, until both LED's flash simultaneously.  **3 s**
2. No object in the detection area:
Press the button for 1 s.  **1 s**
The sensor is set to maximum sensitivity.

NB! The Teach Input (2 WH) will work similarly to the push button, active High.