

Manual Motor Starters

- Complete Ranges up to 100 Amps
- ON-OFF-Trip Three Position Operator
- Unique Handle Lock in the OFF Position
- Class 10, 20 Overload Trip Characteristics
- DIN Rail or Back Panel Mounting
- Finger Safe Terminals
- Trip Test



With
Extended
Warranty



Carlo Gavazzi GMS Manual Motor Starters provide complete ranges up to 100A



32AF

0.1~0.16... 22~32A (16 step)

GMS 32S



• Standard

**GMS 32H
GMS 32HI**



• High break
• Magnetic release

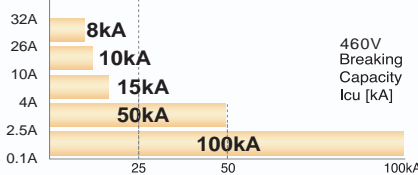

460V
Breaking
Capacity
Icu [kA]

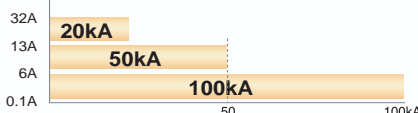

6~10... 45~63A (9 step)

GMS 63S



• Standard

**GMS 63H
GMS 63HI
GMS 63HL**



• High break
• Magnetic release
• Class 20

To instantly specify products, check pricing and availability, visit www.GavazziOnline.com

Gross Automation (877) 268-3700 · www.carlogavazzisales.com · sales@grossautomation.com

up to 100A



GMS

63AF

100AF

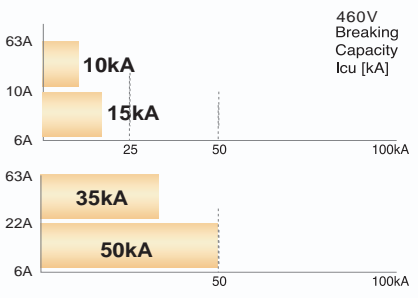

11~17... 80~100A (10 step)

GMS 100S



Standard

GMS 100H
GMS 100HI
GMS 100HL



High break
Magnetic release
Class 20

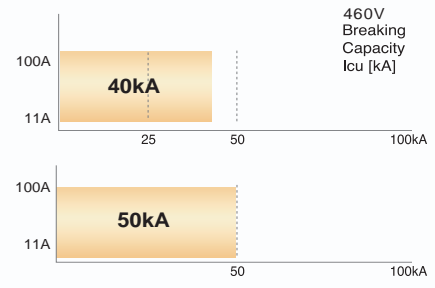

Specifications are subject to change without notice.

Carlo Gavazzi GMS Manual Motor Starters deliver more efficiency through various functions and compact design

[Scale 1:1]

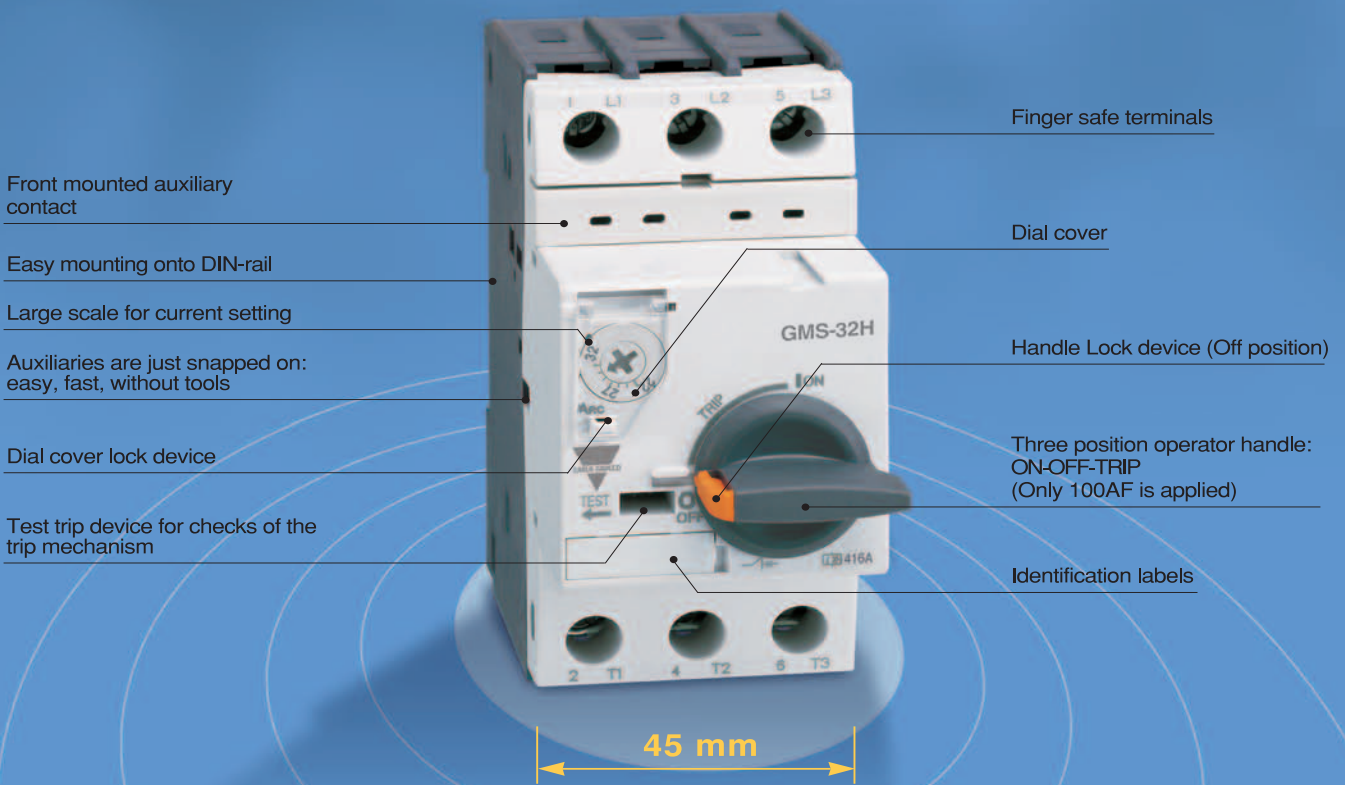

Handle Lock



Dial cover



Terminals

GMS32



GMS63



GMS100



Common use from 32 to 100AF



A wide variety of accessories enables a flexible response to changes in specifications

Accessories
Accessories
Accessories

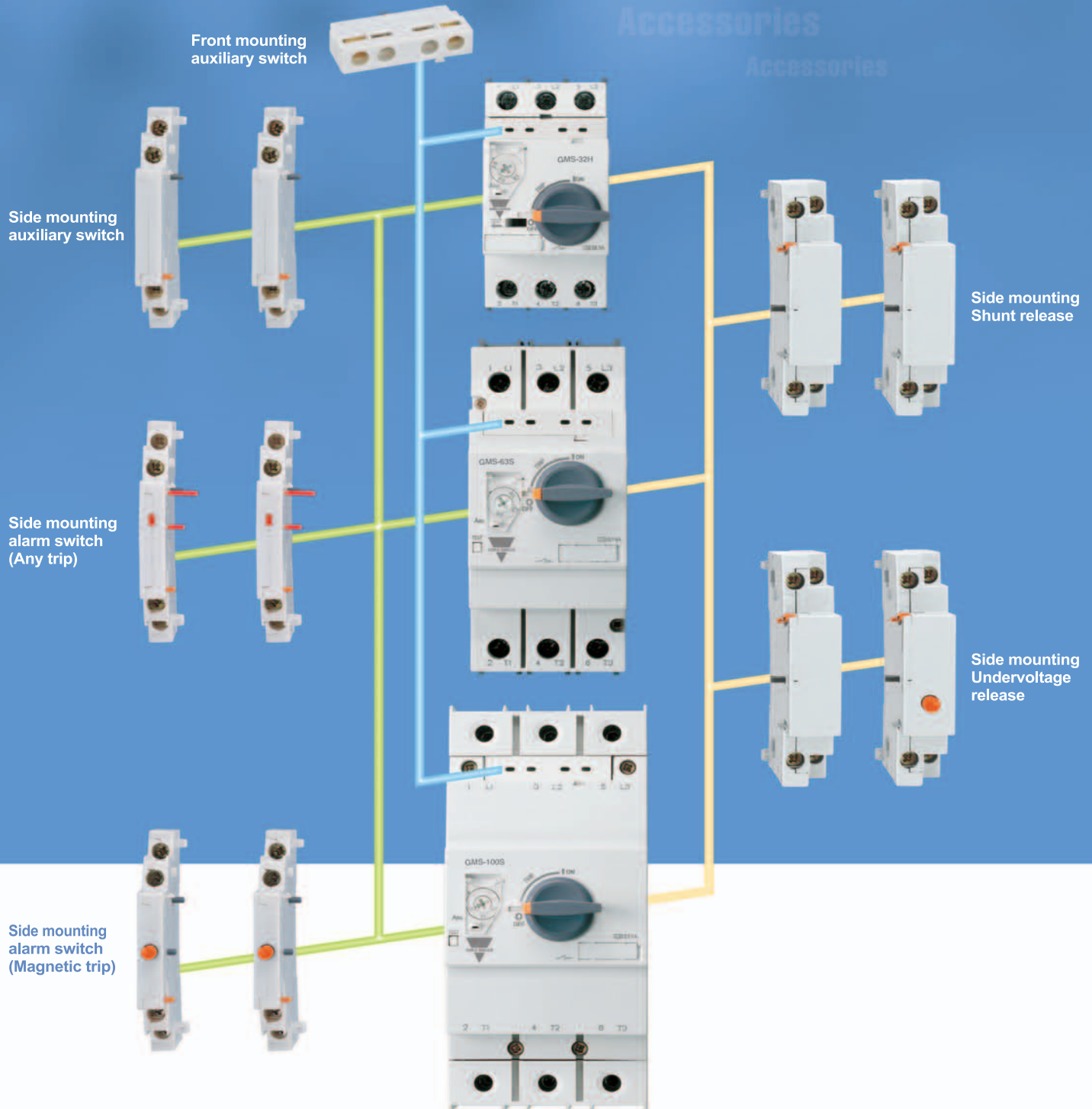

Specifications are subject to change without notice.

Function

- Protection of group installation
- Protection of circuits
- Motor protection
- Starter protection
- Wide range of ambient temperature compensation
- Phase failure protection



Feature

- 45mm width up to 32A, 55mm width up to 63A and 70mm width rated to 100 amps
- Three position operator: ON-OFF-TRIP (Only 100AF is applied)
- Complete range of common accessories
- Handle lock in the OFF position
- Class 10,20 overload trip characteristics
- Trip test
- Finger safe terminal
- DIN rail and screw mounting

Standard

- The components fulfill the international standard IEC 60947
- The devices can be used as Manual Motor Starter in Group Installations According to UL508.



KEMA



KSA
CERTIFICATE OF APPROVAL

IEC 60947

UL 508, UL 508 Type E

To instantly specify products, check pricing and availability, visit www.GavazziOnline.com

Gross Automation (877) 268-3700 · www.carlogavazzisales.com · sales@grossautomation.com

Contents

Product Selection Guide

Quick selection table ...IEC rating	8
Motor protection	10
Short-circuit protection for starters	12
Accessories	14
Busbar Accessories	16

Technical Information

IEC performance data (motor protection).....	18
IEC performance data (Short-circuit protection for starters)	21
IEC Performance data (Motor protection: Class 20)	22
UL/CSA performance data (Motor protection)	23
Manual Motor Controller (UL508)	26
General data	28
Type 'Z' coordination according to IEC 947-4-1	32
Time/Current characteristic	33
Dimensions	34



Product Selection Guide

Quick selection table ... IEC rating



Frame			32AF																				
Type	Current adjustable type		GMS-32S							GMS-32H													
	Instantaneous type		-							GMS-32HI													
	Class 20		-							-													
Breaking capacity			Standard							High break													
Handle Type			Rocker							Rotary													
Number of poles			3							3													
Rated operational voltage (Ue)			Up to 690V							Up to 690V													
Rated frequency			50/60 Hz							50/60 Hz													
Rated insulation voltage (Ui)			690V							690V													
Rated impulse voltage (Uimp)			6kV							6kV													
Utilization category			IEC 60 947-2 (Breaker)							Cat. A													
			IEC 60 947-4 (Motor starter)							AC 3													
Shock resistance (IEC 68 Part 2-27)			25g							25g													
Degree of protection (IEC 60 529)			IP 20							IP 20													
Instantaneous short circuit release			13 × I _e max.							13 × I _e max.													
Mechanical endurance (Operating)			100,000							100,000													
Electrical endurance (Cycles)			100,000							100,000													
Max operating frequency per hour (Ope./h)			25							25													
Temperature compensation (Operation)			-20 ~ +60 °C							-20 ~ +60 °C													
Phase failure function			○							○													
Trip indicating function			×							×													
Test function			○							○													
Rated breaking capacity (kA)	Rated operational current (I _e)	Thermal release Adjustment range (A)	240V		415V		460V		525V		690V		240V		415V		460V		525V		690V		
			230V	400V	440V	500V	600V	230V	400V	440V	500V	600V											
		I _{cu}	I _{cs}	I _{cu}	I _{cs}	I _{cu}	I _{cs}	I _{cu}	I _{cs}	I _{cu}	I _{cs}	I _{cu}	I _{cs}	I _{cu}	I _{cs}	I _{cu}	I _{cs}	I _{cu}	I _{cs}	I _{cu}	I _{cs}		
	0.16	0.1~0.16	100	100	100	100	100	100	100	100	100	100	100	100	100	100	100	100	100	100	100	100	
	0.25	0.16~0.25	100	100	100	100	100	100	100	100	100	100	100	100	100	100	100	100	100	100	100	100	
	0.4	0.25~0.4	100	100	100	100	100	100	100	100	100	100	100	100	100	100	100	100	100	100	100	100	
	0.63	0.4~0.63	100	100	100	100	100	100	100	100	100	100	100	100	100	100	100	100	100	100	100	100	
	1	0.63~1	100	100	100	100	100	100	100	100	100	100	100	100	100	100	100	100	100	100	100	100	
	1.6	1~1.6	100	100	100	100	100	100	100	100	100	3	3	100	100	100	100	100	100	100	100	100	
	2.5	1.6~2.5	100	100	100	100	100	100	50	38	3	3	100	100	100	100	100	100	100	100	100	8	8
	4	2.5~4	100	100	100	100	50	38	15	11	3	3	100	100	100	100	100	100	100	100	100	8	8
	6	4~6	100	100	100	100	15	11	10	8	3	3	100	100	100	100	100	100	100	100	100	6	6
	8	5~8	100	100	100	100	15	11	10	8	3	3	100	100	100	100	50	38	50	38	6	6	
10	6~10	100	100	50	38	15	11	6	5	3	3	100	100	100	100	50	38	50	38	6	6		
13	9~13	100	100	50	38	10	8	6	5	3	3	100	100	100	100	50	38	42	32	6	6		
17	11~17	50	38	20	15	10	8	6	5	3	3	100	100	50	38	20	15	10	8	4	4		
22	14~22	40	30	15	11	8	6	6	5	3	3	100	100	50	38	20	15	10	8	4	4		
26	18~26	40	30	15	11	8	6	6	5	3	3	100	100	50	38	20	15	10	8	4	4		
32	22~32	30	22	15	11	6	4	5	4	3	3	100	100	50	38	20	15	10	8	4	4		
40	28~40	-	-	-	-	-	-	-	-	-	-	-	-	-	-	-	-	-	-	-	-		
50	34~50	-	-	-	-	-	-	-	-	-	-	-	-	-	-	-	-	-	-	-	-		
63	45~63	-	-	-	-	-	-	-	-	-	-	-	-	-	-	-	-	-	-	-	-		
75	55~75	-	-	-	-	-	-	-	-	-	-	-	-	-	-	-	-	-	-	-	-		
90	70~90	-	-	-	-	-	-	-	-	-	-	-	-	-	-	-	-	-	-	-	-		
100	80~100	-	-	-	-	-	-	-	-	-	-	-	-	-	-	-	-	-	-	-	-		

Ordering Example: Specify Rated Operational Current

GMS-32S-0.16 (0.1 to 0.16)

GMS-32S-0.25 (0.16 to 0.25)

To instantly specify products, check pricing and availability, visit www.GavazziOnline.com

Gross Automation (877) 268-3700 · www.carlogavazzisales.com · sales@grossautomation.com

Product Selection Guide

Motor protection

- Adjustable thermal release
- Magnetic release $13 \times I_e$ max.
- Trip class 10
- Ambient temperature compensation
- Phase-failure protection



GMS-32S



GMS-32H

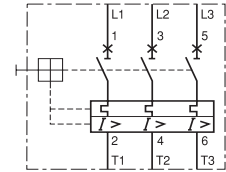

(Circuit diagram)

Type	Rated operational current I_e [A]	Thermal release Adjustment range [A]	Magnetic release Operating current [A]	Switching of 3 phase AC motors, AC-2, AC-3						440/460V		
				3-phase [kW] (50/60Hz)			3-phase [HP] (60Hz)			I_{cu} [kA]	I_{cs} [kA]	
				230V	400V	690V	230V	460V	575V			
GMS-32S (Standard)	0.16	0.1...0.16	2.1	-	0.02	-	-	-	-	-	100	100
	0.25	0.16...0.25	3.3	0.03	0.06	-	-	-	-	-	100	100
	0.4	0.25...0.4	5.2	0.06	0.09	-	-	-	-	-	100	100
	0.63	0.4...0.63	8.2	0.09	0.12	0.25	-	-	-	-	100	100
	1	0.63...1.0	13	0.12	0.25	0.55	-	1/2	1/2	-	100	100
	1.6	1.0...1.6	20.8	0.25	0.55	1.1	1/3	3/4	1	-	100	100
	2.5	1.6...2.5	32.5	0.37	0.75	1.5	1/2	1 1/2	1 1/2	-	100	100
	4	2.5...4.0	52	0.75	1.5	3	1	2	3	-	50	38
	6	4...6	78	1.5	2.2	4	1 1/2	5	5	-	15	11
	8	5...8	104	1.5	3	5.5	2	5	5	-	15	11
	10	6...10	130	3	4	7.5	3	7 1/2	10	-	15	11
	13	9...13	169	3	5.5	11	3	7 1/2	10	-	10	8
	17	11...17	221	4	7.5	11	5	10	15	-	10	8
	22	14...22	286	4	7.5	15	7 1/2	15	20	-	8	6
26	18...26	338	5.5	11	18.5	7 1/2	15	20	-	8	6	
32	22...32	416	7.5	15	22	10	20	30	-	6	4	
GMS-32H (High break)	0.16	0.1...0.16	2.1	-	0.02	-	-	-	-	-	100	100
	0.25	0.16...0.25	3.3	0.03	0.06	-	-	-	-	-	100	100
	0.4	0.25...0.4	5.2	0.06	0.09	-	-	-	-	-	100	100
	0.63	0.4...0.63	8.2	0.09	0.12	0.25	-	-	-	-	100	100
	1	0.63...1.0	13	0.12	0.25	0.55	-	1/2	1/2	-	100	100
	1.6	1.0...1.6	20.8	0.25	0.55	1.1	1/3	3/4	1	-	100	100
	2.5	1.6...2.5	32.5	0.37	0.75	1.5	1/2	1 1/2	1 1/2	-	100	100
	4	2.5...4.0	52	0.75	1.5	3	1	2	3	-	100	100
	6	4...6	78	1.5	2.2	4	1 1/2	5	5	-	100	100
	8	5...8	104	1.5	3	5.5	2	5	5	-	50	38
	10	6...10	130	3	4	7.5	3	7 1/2	10	-	50	38
	13	9...13	169	3	5.5	11	3	7 1/2	10	-	50	38
	17	11...17	221	4	7.5	11	5	10	15	-	20	15
	22	14...22	286	4	7.5	15	7 1/2	15	20	-	20	15
26	18...26	338	5.5	11	18.5	7 1/2	15	20	-	20	15	
32	22...32	416	7.5	15	22	10	20	30	-	20	15	

- Adjustable thermal release
- Magnetic release $13 \times I_e$ max.
- Trip class 10
- Ambient temperature compensation
- Phase-failure protection



GMS-63H



GMS-100H

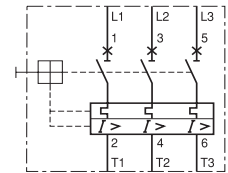

(Circuit diagram)

Type	Rated operational current I_e [A]	Thermal release Adjustment range [A]	Magnetic release Operating current [A]	Switching of 3 phase AC motors, AC-2, AC-3						440/460V	
				3-phase [kW] (50/60Hz)			3-phase [HP] (60Hz)			I_{cu} [kA]	I_{cs} [kA]
				230V	400V	690V	230V	460V	575V		
GMS-63S (Standard)	10	6~10	130	3	4	7.5	3	7½	10	15	12
	13	9~13	169	3	5.5	11	3	7½	10	10	8
	17	11~17	221	4	7.5	11	5	10	15	10	8
	22	14~22	286	4	7.5	15	7½	15	20	10	8
	26	18~26	338	5.5	11	18.5	10	20	25	10	8
	32	22~32	416	7.5	15	22	10	25	30	10	8
	40	28~40	520	7.5	18.5	30	15	30	40	10	8
	50	34~50	650	11	22	45	15	40	50	10	8
GMS-63H (High break)	10	6~10	130	3	4	7.5	3	7½	10	50	38
	13	9~13	169	3	5.5	11	3	7½	10	50	38
	17	11~17	221	4	7.5	11	5	10	15	50	38
	22	14~22	286	4	7.5	15	7½	15	20	50	38
	26	18~26	338	5.5	11	18.5	10	20	25	35	27
	32	22~32	416	7.5	15	22	10	25	30	35	27
	40	28~40	520	7.5	18.5	30	15	30	40	35	27
	50	34~50	650	11	22	45	15	40	50	35	27
GMS-100S (Standard)	17	11~17	221	4	7.5	11	5	10	15	40	30
	22	14~22	286	4	7.5	15	7½	15	20	40	30
	26	18~26	338	5.5	11	18.5	10	20	25	40	30
	32	22~32	416	7.5	15	22	10	25	30	40	30
	40	28~40	520	7.5	18.5	30	15	30	40	40	30
	50	34~50	650	11	22	45	15	40	50	40	30
	63	45~63	819	15	30	55	20	50	60	40	30
	75	55~75	975	22	37	63	25	60	75	40	30
GMS-100H (High break)	17	11~17	221	4	7.5	11	5	10	15	50	38
	22	14~22	286	4	7.5	15	7½	15	20	50	38
	26	18~26	338	5.5	11	18.5	10	20	25	50	38
	32	22~32	416	7.5	15	22	10	25	30	50	38
	40	28~40	520	7.5	18.5	30	15	30	40	50	38
	50	34~50	650	11	22	45	15	40	50	50	38
	63	45~63	819	15	30	55	20	50	60	50	38
	75	55~75	975	22	37	63	25	60	75	50	38
	90	70~90	1170	30	45	75	30	75	100	50	38
	100	80~100	1300	30	45	90	40	75	100	40	30

Specifications are subject to change without notice.

Product Selection Guide

Short-circuit protection for starters

- Without thermal releases
- Magnetic release $13 \times I_e$ max.



GMS-32HI



GMS-63HI



GMS-100HI

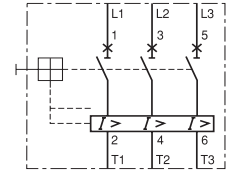

(Circuit diagram)

Type	Rated operational current I_e [A]	Thermal release Adjustment range [A]	Magnetic release Operating current [A]	Switching of 3 phase AC motors, AC-2, AC-3						440/460V	
				3-phase [kW] (50/60Hz)			3-phase [HP] (60Hz)			I_{cu} [kA]	I_{cs} [kA]
				230V	400V	690V	230V	460V	575V		
GMS-32HI (High break)	0.16	-	2.1	-	0.02	-	-	-	-	100	100
	0.25	-	3.3	0.03	0.06	-	-	-	-	100	100
	0.4	-	5.2	0.06	0.09	-	-	-	-	100	100
	0.63	-	8.2	0.09	0.12	0.25	-	-	-	100	100
	1	-	13	0.12	0.25	0.55	-	1/2	1/2	100	100
	1.6	-	20.8	0.25	0.55	1.1	1/3	3/4	1	100	100
	2.5	-	32.5	0.37	0.75	1.5	1/2	1 1/2	1 1/2	100	100
	4	-	52	0.75	1.5	3	1	2	3	100	100
	6	-	78	1.5	2.2	4	1 1/2	5	5	100	100
	8	-	104	1.5	3	5.5	2	5	5	50	38
	10	-	130	3	4	7.5	3	7 1/2	10	50	38
	13	-	169	3	5.5	11	3	7 1/2	10	50	38
	17	-	221	4	7.5	11	5	10	15	20	15
	22	-	286	4	7.5	15	7 1/2	15	20	20	15
26	-	338	5.5	11	18.5	7 1/2	15	20	20	15	
32	-	416	7.5	15	22	10	20	30	20	15	
GMS-63HI (High break)	10	-	130	3	4	7.5	3	7 1/2	10	50	38
	13	-	169	3	5.5	11	3	7 1/2	10	50	38
	17	-	221	4	7.5	11	5	10	15	50	38
	22	-	286	4	7.5	15	7 1/2	15	20	50	38
	26	-	338	5.5	11	18.5	10	20	25	35	27
	32	-	416	7.5	15	22	10	25	30	35	27
	40	-	520	7.5	18.5	30	15	30	40	35	27
50	-	650	11	22	45	15	40	50	35	27	
63	-	819	15	30	55	20	50	60	35	27	
GMS-100HI (High break)	17	-	221	4	7.5	11	5	10	15	50	38
	22	-	286	4	7.5	15	7 1/2	15	20	50	38
	26	-	338	5.5	11	18.5	10	20	25	50	38
	32	-	416	7.5	15	22	10	25	30	50	38
	40	-	520	7.5	18.5	30	15	30	40	50	38
	50	-	650	11	22	45	15	40	50	50	38
	63	-	819	15	30	55	20	50	60	50	38
	75	-	975	22	37	63	25	60	75	50	38
90	-	1170	30	45	75	30	75	100	50	38	
100	-	1300	30	45	90	40	75	100	50	38	



Motor protection ... Class 20

- Adjustable thermal release
- Magnetic release $13 \times I_e$ max.
- Trip class 20
- Ambient temperature compensation
- Phase-failure protection

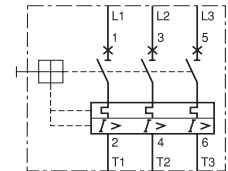





(Circuit diagram)

Type	Rated operational current I_e [A]	Thermal release Adjustment range [A]	Magnetic release Operating current [A]	Switching of 3 phase AC motors, AC-2, AC-3						440/460V	
				3-phase [kW] (50/60Hz)			3-phase [HP] (60Hz)			I_{cu} [kA]	I_{cs} [kA]
				230V	400V	690V	230V	460V	575V		
GMS-63HL (High break)	10	6~10	130	3	4	7.5	3	7½	10	50	38
	13	9~13	169	3	5.5	11	3	7½	10	50	38
	17	11~17	221	4	7.5	11	5	10	15	50	38
	22	14~22	286	4	7.5	15	7½	15	20	50	38
	26	18~26	338	5.5	11	18.5	10	20	25	35	27
	32	22~32	416	7.5	15	22	10	25	30	35	27
	40	28~40	520	7.5	18.5	30	15	30	40	35	27
	50	34~50	650	11	22	45	15	40	50	35	27
GMS-100HL (High break)	63	45~63	819	15	30	55	20	50	60	35	27
	17	11~17	221	4	7.5	11	5	10	15	50	38
	22	14~22	286	4	7.5	15	7½	15	20	50	38
	26	18~26	338	5.5	11	18.5	10	20	25	50	38
	32	22~32	416	7.5	15	22	10	25	30	50	38
	40	28~40	520	7.5	18.5	30	15	30	40	50	38
	50	34~50	650	11	22	45	15	40	50	50	38
	63	45~63	819	15	30	55	20	50	60	50	38
75	55~75	975	22	37	63	25	60	75	50	38	
90	70~90	1170	30	45	75	30	75	100	50	38	
100	80~100	1300	30	45	90	40	75	100	50	38	

Specifications are subject to change without notice.

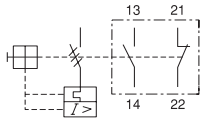
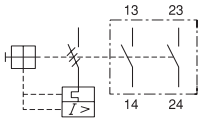
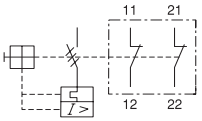

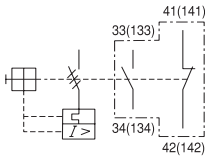
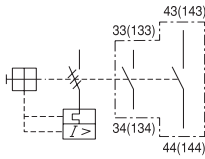
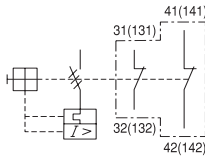
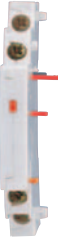
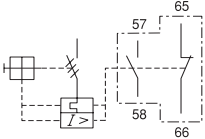
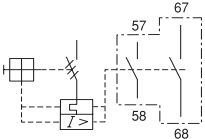
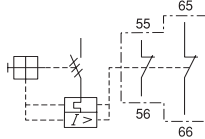

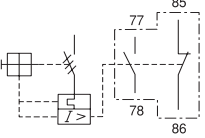
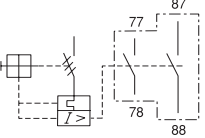
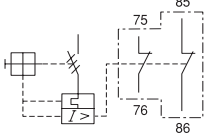
Product Selection Guide

Accessories

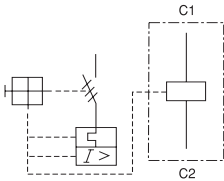

Type	Description	Connection diagram		
GFX... 	Auxiliary Switch <ul style="list-style-type: none"> • Front mounting • 2-pole • One front mounting module per circuit breaker 	1NO1NC  GFX-11	2NO  GFX-20	2NC  GFX-02
GSX... 	Auxiliary Switch <ul style="list-style-type: none"> • Side mounting on the left • 2-pole • One side mounting module per circuit breaker 	1NO1NC  GSX-11	2NO  GSX-20	2NC  GSX-02
GSA... 	Any Trip Alarm Switch <ul style="list-style-type: none"> • Side mounting on the left • 2-pole • One side mounting module per circuit breaker. (Always directly fitted to the circuit breaker). 	1NO1NC  GSA-11	2NO  GSA-20	2NC  GSA-02
GMA... 	Magnetic Trip Alarm Switch <ul style="list-style-type: none"> • Side mounting on the left • 2-pole • One side mounting module per circuit breaker. (Always directly fitted to the circuit breaker except using with Any Trip Alarm Switch). 	1NO1NC  GMA-11	2NO  GMA-20	2NC  GMA-02

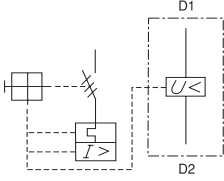
Ordering Example: Specify Contact Arrangement

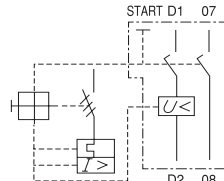
GFX-11 (1NO 1NC)
 GFX-20 (2NO)
 GFX-02 (2NC)

Type	Description	Connection diagram	
GSR... 	Shunt release <ul style="list-style-type: none"> · Side mounting on the right · One side mounting module per circuit breaker. (Always directly fitted to the circuit breaker). 		24V 50Hz / 28V 60Hz 110~127V 50Hz / 120V 60Hz 220~230V 50Hz / 240~260V 60Hz 240V 50Hz / 277V 60Hz 380~400V 50Hz / 440~460V 60Hz 415~440V 50Hz / 460~480V 60Hz
GUR... 	Undervoltage release <ul style="list-style-type: none"> · Side mounting on the right · One side mounting module per circuit breaker. (Always directly fitted to the circuit breaker). 		24V 50Hz / 28V 60Hz 110~127V 50Hz / 120V 60Hz 220~230V 50Hz / 240~260V 60Hz 240V 50Hz / 277V 60Hz 380~400V 50Hz / 440~460V 60Hz 415~440V 50Hz / 460~480V 60Hz
GURX... 	Undervoltage release with Switch (Rotary Handle Only) <ul style="list-style-type: none"> · Side mounting on the right · Include 2NO Auxiliary contact · One side mounting module per circuit breaker. (Always directly fitted to the circuit breaker). 		24V 50Hz / 28V 60Hz 110~127V 50Hz / 120V 60Hz 220~230V 50Hz / 240~260V 60Hz 240V 50Hz / 277V 60Hz 380~400V 50Hz / 440~460V 60Hz 415~440V 50Hz / 460~480V 60Hz

Others

Type	Description	Applied Type
PIL32 	Push-in lug <ul style="list-style-type: none"> · For screwing the MMS on to mounting plates. 	GMS-32S GMS-32H
IB100 	Insulation barriers <ul style="list-style-type: none"> · Insulation barriers with increased creepage distances and clearances for UL 	GMS-100S GMS-100H

Product Selection Guide

Busbar accessories

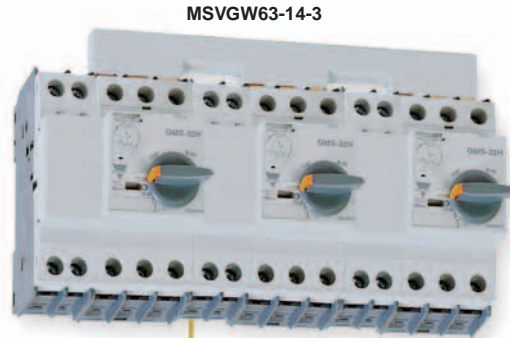

	45mm Spacing (rated 63A)	54mm Spacing (rated 63A)	63mm Spacing (rated 63A)	Jumper
Type	MSVGW45-14-2	MSVGW54-14-2	MSVGW63-14-2	MSVGW45-SH
Description	For 2 GMS-32S/H	For 2 GMS-32S/H + accessories (side mnt aux sw)	For 2 GMS-32S/H + accessories (side mnt undervoltage or shunt trip)	For connecting GMS-32S W/ GMS-32H
Type	MSVGW45-14-3	MSVGW54-14-3	MSVGW63-14-3	
Description	For 3 GMS-32S/H	For 3 GMS-32S/H + accessories (side mnt aux. sw)	For 3 GMS-32S/H + accessories (side mnt undervoltage or shunt trip)	
Type	MSVGW45-14-4	MSVGW54-14-4	MSVGW63-14-4	
Description	For 4 GMS-32S/H	For 4 GMS-32S/H + accessories (side mnt aux. sw)	For 4 GMS-32S/H + accessories (side mnt undervoltage or shunt trip)	
Type	MSVGW45-14-5	MSVGW54-14-5	MSVGW63-14-5	
Description	For 5 GMS-32S/H	For 5 GMS-32S/H + accessories (side mnt aux. sw)	For 5 GMS-32S/H + accessories (side mnt undervoltage or shunt trip)	

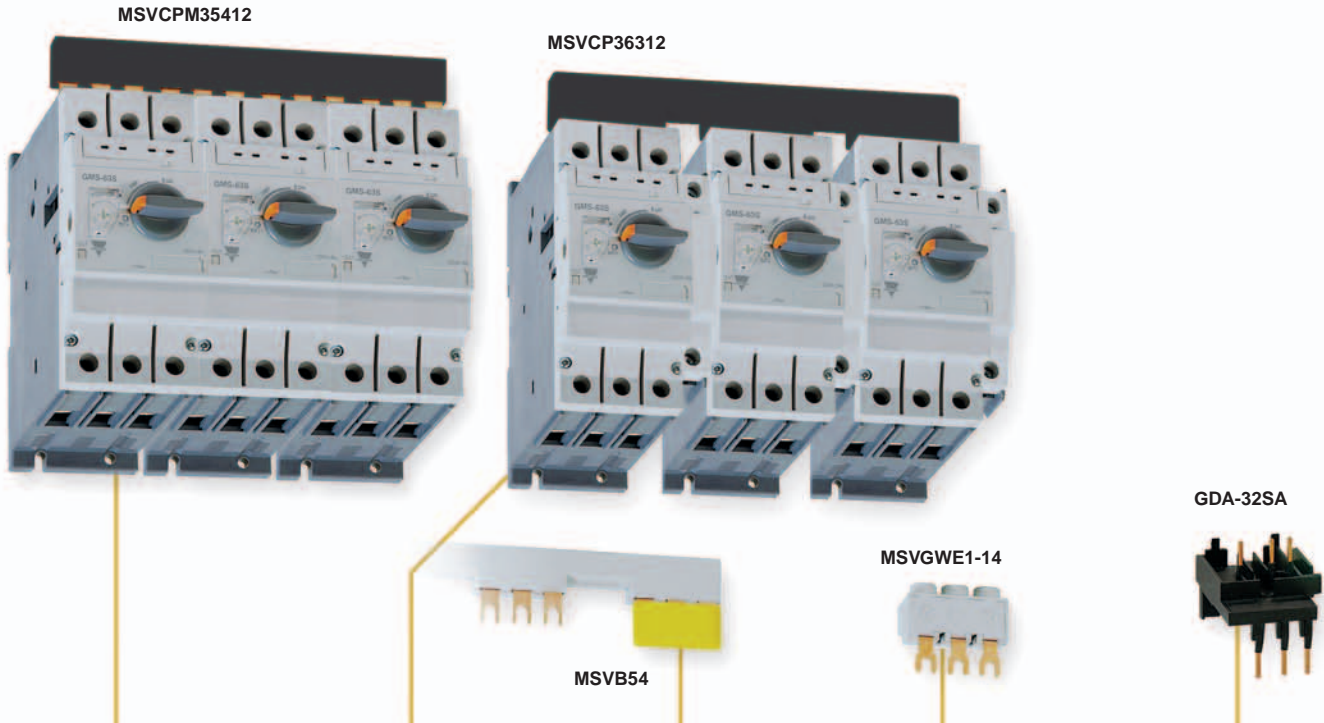

54mm Spacing (rated 120A)	63mm Spacing (rated 120A)	Terminal cover	Supply connector	Connection module
MSVCPM25412	MSVCP36312	MSVB54	MSVGWE1-14	GDA-32SA
For 2 GMS-63	For 2 GMS-63 + accessories (side mnt aux sw)	3 Pole protective cover for MSVGW..	3 Phase input terminal 63A	For connecting GMS-32S to CGMS-6A - CGMS-12A
MSVCPM35412	MSVCP36312	MSVTA120	MSVBTC50E	GDA-32SD
For 3 GMS-63	For 3 GMS-63 + accessories (side mnt aux. sw)	3 Pole protective cover for MSVCP..	3 Phase Input terminal 120A	For connecting GMS-32S to CGMS-6D - CGMS-12D
MSVCPM45412	MSVCP46312			GDA-32HA
For 4 GMS-63	For 4 GMS-63 + accessories (side mnt aux. sw)			For connecting GMS-32H to CGMS-6A - CGMS-12A
				GDA-32HD
				For connecting GMS-32H to CGMS-6D - CGMS-12D

Specifications are subject to change without notice.

Technical Information

IEC performance data (Motor protection)

● GMS-32S

Rated operational current I_e [A]	0.16	0.25	0.4	0.63	1	1.6	2.5	4	6	8	10	13	17	22	26	32
Switching of standard three-phase motors																
AC-2, AC-3																
230/240V [kW]	-	0.03	0.06	0.09	0.12	0.18/0.25	0.37	0.55/0.75	1.1/1.5	1.5	2.2/3	3	3.7/4	4	5.5	7.5
400/415V [kW]	0.02	0.06	0.09	0.12	0.18/0.25	0.37/0.55	0.75	1.1/1.5	2.2	3	3.7/4	5.5	7.5	7.5	11	15
500V [kW]	-	-	-	0.25	0.37	0.55/0.75	1.1	1.5/2.2	3	3.7	4/5.5	7.5	11	11	15	18.5
690V [kW]	-	-	-	0.25	0.37/0.55	0.75/1.1	1.5	2.2/3	3.7/4	5.5	7.5	11	11	15	18.5	22
Back-up fuses																
gG, gL,, only if $I_{cc} > I_{cu}$ (* = No back up fuse required)																
230/240V [A]	*	*	*	*	*	*	*	*	*	*	*	*	*	*	*	*
400/415V [A]	*	*	*	*	*	*	*	*	*	*	80	80	100	100	100	100
440/460V [A]	*	*	*	*	*	*	*	50	50	63	63	80	80	100	100	100
500V [A]	*	*	*	*	*	*	50	40	50	63	63	80	80	80	80	80
690V [A]	*	*	*	*	*	20	35	40	50	63	63	63	63	63	63	63
Ultimate short-circuit breaking capacity I_{cu}																
230/240V [kA]	100	100	100	100	100	100	100	100	100	100	100	100	50	40	40	30
400/415V [kA]	100	100	100	100	100	100	100	100	100	100	50	50	20	15	15	15
440/460V [kA]	100	100	100	100	100	100	100	50	15	15	15	10	8	8	8	6
500V [kA]	100	100	100	100	100	100	50	15	10	10	6	6	6	6	6	5
690V [kA]	100	100	100	100	100	3	3	3	3	3	3	3	3	3	3	3
Rated service short-circuit breaking capacity I_{cs}																
230/240V [kA]	100	100	100	100	100	100	100	100	100	100	100	100	38	30	30	22
400/415V [kA]	100	100	100	100	100	100	100	100	100	100	38	38	15	11	11	11
440/460V [kA]	100	100	100	100	100	100	100	38	11	11	11	8	8	6	6	4
500V [kA]	100	100	100	100	100	100	38	11	8	8	5	5	5	5	5	4
690V [kA]	100	100	100	100	100	3	3	3	3	3	3	3	3	3	3	3

● GMS-32H

Rated operational current I_e [A]	0.16	0.25	0.4	0.63	1	1.6	2.5	4	6	8	10	13	17	22	26	32
Switching of standard three-phase motors																
AC-2, AC-3																
230/240V [kW]	-	0.03	0.06	0.09	0.12	0.18/0.25	0.37	0.55/0.75	1.1/1.5	1.5	2.2/3	3	3.7/4	4	5.5	7.5
400/415V [kW]	0.02	0.06	0.09	0.12	0.18/0.25	0.37/0.55	0.75	1.1/1.5	2.2	3	3.7/4	5.5	7.5	7.5	11	15
500V [kW]	-	-	-	0.25	0.37	0.55/0.75	1.1	1.5/2.2	3	3.7	4/5.5	7.5	11	11	15	18.5
690V [kW]	-	-	-	0.25	0.37/0.55	0.75/1.1	1.5	2.2/3	3.7/4	5.5	7.5	11	11	15	18.5	22
Back-up fuses																
gG, gL,, only if $I_{cc} > I_{cu}$ (* = No back up fuse required)																
230/240V [A]	*	*	*	*	*	*	*	*	*	*	*	*	*	*	*	*
400/415V [A]	*	*	*	*	*	*	*	*	*	*	*	*	100	125	125	125
440/460V [A]	*	*	*	*	*	*	*	*	*	80	80	80	80	100	100	100
500V [A]	*	*	*	*	*	*	*	*	*	63	80	80	80	80	80	80
690V [A]	*	*	*	*	*	*	35	40	50	63	63	63	63	63	63	63
Ultimate short-circuit breaking capacity I_{cu}																
230/240V [kA]	100	100	100	100	100	100	100	100	100	100	100	100	100	100	100	100
400/415V [kA]	100	100	100	100	100	100	100	100	100	100	100	100	50	50	50	50
440/460V [kA]	100	100	100	100	100	100	100	100	100	50	50	50	20	20	20	20
500V [kA]	100	100	100	100	100	100	100	100	100	50	50	42	10	10	10	10
690V [kA]	100	100	100	100	100	100	8	8	6	6	6	6	4	4	4	4
Rated service short-circuit breaking capacity I_{cs}																
230/240V [kA]	100	100	100	100	100	100	100	100	100	100	100	100	100	100	100	100
400/415V [kA]	100	100	100	100	100	100	100	100	100	100	100	100	38	38	38	38
440/460V [kA]	100	100	100	100	100	100	100	100	100	38	38	38	15	15	15	15
500V [kA]	100	100	100	100	100	100	100	100	100	38	38	32	8	8	8	8
690V [kA]	100	100	100	100	100	100	8	8	6	6	6	6	4	4	4	4

Note) * = Short circuit proof up to 50 or 100kA.
No back up fuse required.



● GMS-63S

Rated operational current I_e [A]		10	13	17	22	26	32	40	50	63
Switching of standard three-phase motors										
AC-2, AC-3										
230/240V	[kW]	2.2/3	3	3.7/4	4	5.5	7.5	7.5	11	15
400/415V	[kW]	3.7/4	5.5	7.5	7.5	11	15	18.5	22	30
500V	[kW]	4/5.5	7.5	11	11	15	18.5	22	30	37
690V	[kW]	7.5	11	11	15	18.5	22	30	45	55
Back-up fuses										
gG, gL, only if $I_{cc} > I_{cu}$ (* = No back up fuse required)										
230/240V	[A]	*	*	*	125	125	160	160	160	200
400/415V	[A]	*	80	100	125	125	125	125	160	160
440/460V	[A]	80	80	100	100	100	100	100	100	125
500V	[A]	80	80	80	80	80	80	80	80	80
690V	[A]	63	63	63	63	63	63	63	63	80
Ultimate short-circuit breaking capacity I_{cu}										
230/240V	[kA]	100	100	100	50	50	50	50	50	50
400/415V	[kA]	100	50	25	25	25	25	25	25	25
440/460V	[kA]	15	10	10	10	10	10	10	10	10
500V	[kA]	10	6	6	6	6	6	6	6	6
690V	[kA]	4	4	4	4	4	4	4	4	4
Rated service short-circuit breaking capacity I_{cs}										
230/240V	[kA]	100	100	100	38	38	38	38	38	38
400/415V	[kA]	100	38	19	19	19	19	19	19	19
440/460V	[kA]	12	8	8	8	8	8	8	8	8
500V	[kA]	8	5	5	5	5	5	5	5	5
690V	[kA]	3	3	3	3	3	3	3	3	3



● GMS-63H

Rated operational current I_e [A]		10	13	17	22	26	32	40	50	63
Switching of standard three-phase motors										
AC-2, AC-3										
230/240V	[kW]	2.2/3	3	3.7/4	4	5.5	7.5	7.5	11	15
400/415V	[kW]	3.7/4	5.5	7.5	7.5	11	15	18.5	22	30
500V	[kW]	4/5.5	7.5	11	11	15	18.5	22	30	37
690V	[kW]	7.5	11	11	15	18.5	22	30	45	55
Back-up fuses										
gG, gL, only if $I_{cc} > I_{cu}$ (* = No back up fuse required)										
230/240V	[A]	*	*	*	*	*	*	*	*	*
400/415V	[A]	*	*	100	125	125	125	160	160	160
440/460V	[A]	100	100	100	125	125	125	125	125	160
500V	[A]	100	100	100	100	100	100	100	100	100
690V	[A]	63	63	63	80	80	80	80	80	80
Ultimate short-circuit breaking capacity I_{cu}										
230/240V	[kA]	100	100	100	100	100	100	100	100	100
400/415V	[kA]	100	100	50	50	50	50	50	50	50
440/460V	[kA]	50	50	50	50	35	35	35	35	35
500V	[kA]	50	42	12	12	12	10	10	10	10
690V	[kA]	6	6	5	5	5	5	5	5	5
Rated service short-circuit breaking capacity I_{cs}										
230/240V	[kA]	100	100	100	100	100	100	100	100	100
400/415V	[kA]	100	100	50	50	50	50	50	50	50
440/460V	[kA]	38	38	38	38	27	27	27	27	27
500V	[kA]	38	32	9	9	9	8	8	8	8
690V	[kA]	5	5	5	5	5	5	5	5	5

Note) * = Short circuit proof up to 50 or 100kA.
No back up fuse required.

IEC performance data (Motor protection)



● GMS-100S

Rated operational current I_e [A]		17	22	26	32	40	50	63	75	90	100
Switching of standard three-phase motors											
AC-2, AC-3											
230/240V [kW]		3.7/4	4	5.5	7.5	7.5	11	15	22	30	30
400/415V [kW]		7.5	7.5	11	15	18.5	22	30	37	45	45
500V [kW]		11	11	15	18.5	22	30	37	45	55	63
690V [kW]		11	15	18.5	22	30	45	55	63	75	90
Back-up fuses											
gG, gL., only if $I_{cc} > I_{cu}$ (* = No back up fuse required)											
230/240V [A]		*	*	*	*	*	*	*	*	*	*
400/415V [A]		100	125	125	125	160	160	160	160	160	160
440/460V [A]		100	125	125	125	125	125	160	160	160	160
500V [A]		100	100	100	100	100	100	100	125	125	125
690V [A]		63	80	80	80	80	80	80	100	125	125
Ultimate short-circuit breaking capacity I_{cu}											
230/240V [kA]		100	100	100	100	100	100	100	100	100	100
400/415V [kA]		50	50	50	50	50	50	50	50	50	50
440/460V [kA]		40	40	40	40	40	40	40	40	40	40
500V [kA]		25	25	25	15	15	12	12	8	8	8
690V [kA]		10	10	10	10	6	6	6	5	5	5
Rated service short-circuit breaking capacity I_{cs}											
230/240V [kA]		100	100	100	100	100	100	100	100	100	100
400/415V [kA]		38	38	38	38	38	38	38	38	38	38
440/460V [kA]		30	30	30	30	30	30	30	30	30	30
500V [kA]		19	19	19	11	11	9	9	6	6	6
690V [kA]		8	8	8	8	5	5	5	4	4	4



● GMS-100H

Rated operational current I_e [A]		17	22	26	32	40	50	63	75	90	100
Switching of standard three-phase motors											
AC-2, AC-3											
230/240V [kW]		3.7/4	4	5.5	7.5	7.5	11	15	22	30	30
400/415V [kW]		7.5	7.5	11	15	18.5	22	30	37	45	45
500V [kW]		11	11	15	18.5	22	30	37	45	55	63
690V [kW]		11	15	18.5	22	30	45	55	63	75	90
Back-up fuses											
gG, gL., only if $I_{cc} > I_{cu}$ (* = No back up fuse required)											
230/240V [A]		*	*	*	*	*	*	*	*	*	*
400/415V [A]		*	*	*	*	*	*	*	*	*	*
440/460V [A]		125	125	125	160	160	160	200	200	200	200
500V [A]		100	125	125	125	160	160	160	160	160	160
690V [A]		80	80	80	80	80	100	100	125	160	160
Ultimate short-circuit breaking capacity I_{cu}											
230/240V [kA]		100	100	100	100	100	100	100	100	100	100
400/415V [kA]		100	100	100	100	100	100	100	75	75	75
440/460V [kA]		50	50	50	50	50	50	50	50	50	50
500V [kA]		35	35	35	25	20	15	15	12	12	12
690V [kA]		12	12	12	12	12	10	8	6	6	6
Rated service short-circuit breaking capacity I_{cs}											
230/240V [kA]		100	100	100	100	100	100	100	100	100	100
400/415V [kA]		100	50	50	50	50	50	50	50	50	50
440/460V [kA]		38	38	38	38	38	38	38	38	38	38
500V [kA]		27	27	27	19	15	11	11	9	9	9
690V [kA]		9	9	9	9	9	8	6	6	6	6

Note) * = Short circuit proof up to 50 or 100kA.
No back up fuse required.

IEC performance data (Short-circuit protection for starters)



● GMS-32HI

Rated operational current I _e	[A]	0.16	0.25	0.4	0.63	1	1.6	2.5	4	6	8	10	13	17	22	26	32
AC-2, AC-3																	
230/240V	[kW]	-	0.03	0.06	0.09	0.12	0.18/0.25	0.37	0.55/0.75	1.1/1.5	1.5	2.2/3	3	3.7/4	4	5.5	7.5
400/415V	[kW]	0.02	0.06	0.09	0.12	0.18/0.25	0.37/0.55	0.75	1.1/1.5	2.2	3	3.7/4	5.5	7.5	7.5	11	15
500V	[kW]	-	-	-	0.25	0.37	0.55/0.75	1.1	1.5/2.2	3	3.7	4/5.5	7.5	11	11	15	18.5
690V	[kW]	-	-	-	0.25	0.37/0.55	0.75/1.1	1.5	2.2/3	3.7/4	5.5	7.5	11	11	15	18.5	22
Back-up fuses gG, gL, only if I _{cc} >I _{cu} (* = No back up fuse required)																	
230/240V	[A]	*	*	*	*	*	*	*	*	*	*	*	*	*	*	*	*
400/415V	[A]	*	*	*	*	*	*	*	*	*	*	*	*	100	125	125	125
440/460V	[A]	*	*	*	*	*	*	*	*	*	80	80	80	80	100	100	100
500V	[A]	*	*	*	*	*	*	*	*	*	63	80	80	80	80	80	80
690V	[A]	*	*	*	*	*	*	35	40	50	63	63	63	63	63	63	63
Ultimate short-circuit breaking capacity I_{cu}																	
230/240V	[kA]	100	100	100	100	100	100	100	100	100	100	100	100	100	100	100	100
400/415V	[kA]	100	100	100	100	100	100	100	100	100	100	100	100	50	50	50	50
440/460V	[kA]	100	100	100	100	100	100	100	100	100	50	50	50	20	20	20	20
500V	[kA]	100	100	100	100	100	100	100	100	100	50	50	42	10	10	10	10
690V	[kA]	100	100	100	100	100	100	8	8	6	6	6	6	4	4	4	4
Rated service short-circuit breaking capacity I_{cs}																	
230/240V	[kA]	100	100	100	100	100	100	100	100	100	100	100	100	100	100	100	100
400/415V	[kA]	100	100	100	100	100	100	100	100	100	100	100	100	38	38	38	38
440/460V	[kA]	100	100	100	100	100	100	100	100	100	38	38	38	15	15	15	15
500V	[kA]	100	100	100	100	100	100	100	100	100	38	38	32	8	8	8	8
690V	[kA]	100	100	100	100	100	100	8	8	6	6	6	6	4	4	4	4

● GMS-63HI

Rated operational current I _e	[A]	10	13	17	22	26	32	40	50	63
AC-2, AC-3										
230/240V	[kW]	2.2/3	3	3.7/4	4	5.5	7.5	7.5	11	15
400/415V	[kW]	3.7/4	5.5	7.5	7.5	11	15	18.5	22	30
500V	[kW]	4/5.5	7.5	11	11	15	18.5	22	30	37
690V	[kW]	7.5	11	11	15	18.5	22	30	45	55
Back-up fuses gG, gL, only if I _{cc} >I _{cu} (* = No back up fuse required)										
230/240V	[A]	*	*	*	*	*	*	*	*	*
400/415V	[A]	*	*	100	125	125	125	160	160	160
440/460V	[A]	100	100	100	125	125	125	125	125	160
500V	[A]	100	100	100	100	100	100	100	100	100
690V	[A]	63	63	63	80	80	80	80	80	80
Ultimate short-circuit breaking capacity I_{cu}										
230/240V	[kA]	100	100	100	100	100	100	100	100	100
400/415V	[kA]	100	100	50	50	50	50	50	50	50
440/460V	[kA]	50	50	50	50	35	35	35	35	35
500V	[kA]	50	42	12	12	10	10	10	10	10
690V	[kA]	6	6	5	5	5	5	5	5	5
Rated service short-circuit breaking capacity I_{cs}										
230/240V	[kA]	100	100	100	100	100	100	100	100	100
400/415V	[kA]	100	100	50	50	50	50	50	50	50
440/460V	[kA]	38	38	38	38	27	27	27	27	27
500V	[kA]	38	32	9	9	8	8	8	8	8
690V	[kA]	5	5	5	5	5	5	5	5	5

● GMS-100HI

Rated operational current I _e	[A]	17	22	26	32	40	50	63	75	90	100
AC-2, AC-3											
230/240V	[kW]	3.7/4	4	5.5	7.5	7.5	11	15	22	30	30
400/415V	[kW]	7.5	7.5	11	15	18.5	22	30	37	45	45
500V	[kW]	11	11	15	18.5	22	30	37	45	55	63
690V	[kW]	11	15	18.5	22	30	45	55	63	75	90
Back-up fuses gG, gL, only if I _{cc} >I _{cu} (* = No back up fuse required)											
230/240V	[A]	*	*	*	*	*	*	*	*	*	*
400/415V	[A]	*	*	*	*	*	*	*	*	*	*
440/460V	[A]	125	125	125	160	160	160	200	200	200	200
500V	[A]	100	125	125	125	160	160	160	160	160	160
690V	[A]	80	80	80	80	80	100	100	125	160	160
Ultimate short-circuit breaking capacity I_{cu}											
230/240V	[kA]	100	100	100	100	100	100	100	100	100	100
400/415V	[kA]	100	100	100	100	100	100	100	75	75	75
440/460V	[kA]	50	50	50	50	50	50	50	50	50	50
500V	[kA]	35	35	35	25	20	15	15	12	12	12
690V	[kA]	12	12	12	12	12	10	8	6	6	6
Rated service short-circuit breaking capacity I_{cs}											
230/240V	[kA]	100	100	100	100	100	100	100	100	100	100
400/415V	[kA]	100	50	50	50	50	50	50	50	50	50
440/460V	[kA]	38	38	38	38	38	38	38	38	38	38
500V	[kA]	27	27	27	19	15	11	11	9	9	9
690V	[kA]	9	9	9	9	9	8	6	6	6	6

Specifications are subject to change without notice.

Technical Information

IEC performance data (Motor protection ; Class 20)



● GMS-63HL

Rated operational current I_e [A]		10	13	17	22	26	32	40	50	63
Switching of standard three-phase motors										
AC-2, AC-3										
230/240V [kW]		2.2/3	3	3.7/4	4	5.5	7.5	7.5	11	15
400/415V [kW]		3.7/4	5.5	7.5	7.5	11	15	18.5	22	30
500V [kW]		4/5.5	7.5	11	11	15	18.5	22	30	37
690V [kW]		7.5	11	11	15	18.5	22	30	45	55
Back-up fuses										
gG, gL, only if $I_{cc} > I_{cu}$										
(* = No back up fuse required)										
230/240V [A]		*	*	*	*	*	*	*	*	*
400/415V [A]		*	*	100	125	125	125	160	160	160
440/460V [A]		100	100	100	125	125	125	125	125	160
500V [A]		100	100	100	100	100	100	100	100	100
690V [A]		63	63	63	80	80	80	80	80	80
Ultimate short-circuit breaking capacity I_{cu}										
230/240V [kA]		100	100	100	100	100	100	100	100	100
400/415V [kA]		100	100	50	50	50	50	50	50	50
440/460V [kA]		50	50	50	50	35	35	35	35	35
500V [kA]		50	42	12	12	10	10	10	10	10
690V [kA]		6	6	5	5	5	5	5	5	5
Rated service short-circuit breaking capacity I_{cs}										
230/240V [kA]		100	100	100	100	100	100	100	100	100
400/415V [kA]		100	100	50	50	50	50	50	50	50
440/460V [kA]		38	38	38	38	27	27	27	27	27
500V [kA]		38	32	9	9	8	8	8	8	8
690V [kA]		5	5	5	5	5	5	5	5	5



● GMS-100HL

Rated operational current I_e [A]		17	22	26	32	40	50	63	75	90	100
Switching of standard three-phase motors											
AC-2, AC-3											
230/240V [kW]		3.7/4	4	5.5	7.5	7.5	11	15	22	30	30
400/415V [kW]		7.5	7.5	11	15	18.5	22	30	37	45	45
500V [kW]		11	11	15	18.5	22	30	37	45	55	63
690V [kW]		11	15	18.5	22	30	45	55	63	75	90
Back-up fuses											
gG, gL, only if $I_{cc} > I_{cu}$											
(* = No back up fuse required)											
230/240V [A]		*	*	*	*	*	*	*	*	*	*
400/415V [A]		*	*	*	*	*	*	*	*	*	*
440/460V [A]		125	125	125	160	160	160	200	200	200	200
500V [A]		100	125	125	125	160	160	160	160	160	160
690V [A]		80	80	80	80	80	100	100	125	160	160
Ultimate short-circuit breaking capacity I_{cu}											
230/240V [kA]		100	100	100	100	100	100	100	100	100	100
400/415V [kA]		100	100	100	100	100	100	100	75	75	75
440/460V [kA]		50	50	50	50	50	50	50	50	50	50
500V [kA]		35	35	35	25	20	15	15	12	12	12
690V [kA]		12	12	12	12	12	10	8	6	6	6
Rated service short-circuit breaking capacity I_{cs}											
230/240V [kA]		100	100	100	100	100	100	100	100	100	100
400/415V [kA]		100	50	50	50	50	50	50	50	50	50
440/460V [kA]		38	38	38	38	38	38	38	38	38	38
500V [kA]		27	27	27	19	15	11	11	9	9	9
690V [kA]		9	9	9	9	9	8	6	6	6	6

Note) * = Short circuit proof up to 50 or 100kA.
No back up fuse required.



UL/CSA performance data (Motor protection)

Manual motor controller

(UL 508, CSA C22.2 as Manual motor controllers)

● **GMS-32S**

Rated operational current I _e	[A]	0.16	0.25	0.4	0.63	1	1.6	2.5	4	6	8	10	13	17	22	26	32	
Max. short-circuit current																		
240V	[kA]	100	100	100	100	100	100	100	100	100	100	50	50	40	30	30	20	
480Y/277V	[kA]	50	50	50	50	50	50	50	50	25	25	10	10	10	10	7.5	7.5	
600Y/347V	[kA]	10	10	10	10	10	10	10	5	5	5	5	5	5	5	5	5	
Motor load																		
1 Phase	115V	[HP]	-	-	-	-	-	-	1/8	1/4	1/3	1/2	1/2	1	2	2	2	
	230V	[HP]	-	-	-	-	-	1/10	1/6	1/3	3/4	1	1½	2	3	3	5	
3 Phase	230V	[HP]	-	-	-	-	-	1/3	1/2	1	1½	2	3	3	5	7½	7½	10
	460V	[HP]	-	-	-	-	1/2	3/4	1½	2	5	5	7½	7½	10	15	15	20
	575V	[HP]	-	-	-	-	1/2	1	1½	3	5	5	10	10	15	20	20	30
Maximum rated current of fuse or breaker		[A]	500	500	500	500	500	500	500	500	500	500	500	500	500	500	500	

Manual motor controller "group installation" or "Type E starter"

(UL 508, CSA C22.2 No..14, for group installation, in connection with a short-circuit protection device)

● **GMS-32H**

Rated operational current I _e	[A]	0.16	0.25	0.4	0.63	1	1.6	2.5	4	6	8	10	13	17	22	26	32	
Max. short-circuit current																		
240V	[kA]	100	100	100	100	100	100	100	100	100	100	100	100	100	100	100	100	
480Y/277V	[kA]	65	65	65	65	65	65	65	65	65	65	65	65	30	30	30	30	
600Y/347V	[kA]	25	25	25	25	25	25	25	25	25	25	25	25	10	10	10	10	
Motor load																		
1 Phase	115V	[HP]	-	-	-	-	-	-	1/8	1/4	1/3	1/2	1/2	1	2	2	2	
	230V	[HP]	-	-	-	-	-	1/10	1/6	1/3	3/4	1	1½	2	3	3	5	
3 Phase	230V	[HP]	-	-	-	-	-	1/3	1/2	1	1½	2	3	3	5	7½	7½	10
	460V	[HP]	-	-	-	-	1/2	3/4	1½	2	5	5	7½	7½	10	15	15	20
	575V	[HP]	-	-	-	-	1/2	1	1½	3	5	5	10	10	15	20	20	30
Maximum rated current of fuse or breaker		[A]	500	500	500	500	500	500	500	500	500	500	500	500	500	500	500	



Specifications are subject to change without notice.

Technical Information

UL/CSA performance data (Motor protection)

Manual motor controller "group installation" or "Type E starter"
(UL 508, CSA C22.2 No. 14, for group installation, in connection with a short-circuit protection device)



● GMS-63S

Rated operational current I _e	[A]	10	13	17	22	26	32	40	50	63	
Max. short-circuit current											
240V	[kA]	100	100	100	100	100	100	100	100	100	
480Y/277V	[kA]	50	50	40	40	40	40	40	40	40	
600Y/347V	[kA]	10	10	10	10	10	10	10	10	10	
Motor load											
1 Phase	115V	[HP]	1/2	1/2	1	2	2	3	3	5	5
	230V	[HP]	1½	2	3	3	5	5	7½	10	15
3 Phase	230V	[HP]	3	3	5	7½	10	10	15	15	20
	460V	[HP]	7½	7½	10	15	20	25	30	40	50
	575V	[HP]	10	10	15	20	25	30	40	50	60
Maximum rated current of fuse or breaker		[A]	600	600	600	600	600	600	600	600	



● GMS-63H

Rated operational current I _e	[A]	10	13	17	22	26	32	40	50	63	
Max. short-circuit current											
240V	[kA]	100	100	100	100	100	100	100	100	100	
480Y/277V	[kA]	65	65	50	50	50	50	50	50	50	
600Y/347V	[kA]	25	25	10	10	10	10	10	10	10	
Motor load											
1 Phase	115V	[HP]	1/2	1/2	1	2	2	3	3	5	5
	230V	[HP]	1½	2	3	3	5	5	7½	10	15
3 Phase	230V	[HP]	3	3	5	7½	10	10	15	15	20
	460V	[HP]	7½	7½	10	15	20	25	30	40	50
	575V	[HP]	10	10	15	20	25	30	40	50	60
Maximum rated current of fuse or breaker		[A]	600	600	600	600	600	600	600	600	



Manual motor controller "group installation" or "Type E starter"
 (UL 508, CSA C22.2 No..14, for group installation, in connection with a
 short-circuit protection device)

● GMS-100S



Rated operational current I _e	[A]	17	22	26	32	40	50	63	75	90	100	
Max. short-circuit current												
240V	[kA]	100	100	100	100	100	100	100	100	100	100	
480Y/277V	[kA]	50	50	50	50	50	50	40	40	40	40	
600Y/347V	[kA]	10	10	10	10	10	10	10	10	10	10	
Motor load												
1 Phase	115V	[HP]	1	1½	2	3	3	5	5	7½	10	10
	230V	[HP]	3	3	5	5	7½	10	15	15	20	20
3 Phase	230V	[HP]	5	7½	10	10	15	15	20	25	30	40
	460V	[HP]	10	15	20	25	30	40	50	60	75	75
	575V	[HP]	15	20	25	30	40	50	60	75	100	100
Maximum rated current of fuse or breaker		[A]	1000	1000	1000	1000	1000	1000	1000	1000	1000	

● GMS-100H



Rated operational current I _e	[A]	17	22	26	32	40	50	63	75	90	100	
Max. short-circuit current												
240V	[kA]	100	100	100	100	100	100	100	100	100	100	
480Y/277V	[kA]	65	65	65	65	65	65	50	50	50	50	
600Y/347V	[kA]	25	20	20	20	20	20	10	10	10	10	
Motor load												
1 Phase	115V	[HP]	1	1½	2	3	3	5	5	7½	10	10
	230V	[HP]	3	3	5	5	7½	10	15	15	20	20
3 Phase	230V	[HP]	5	7½	10	10	15	15	20	25	30	40
	460V	[HP]	10	15	20	25	30	40	50	60	75	75
	575V	[HP]	15	20	25	30	40	50	60	75	100	100
Maximum rated current of fuse or breaker		[A]	1000	1000	1000	1000	1000	1000	1000	1000	1000	

Technical Information

Manual Motor Controller (UL508)

● GMS-32S

Rated operational current I _e		[A]	0.16	0.25	0.4	0.63	1	1.6	2.5	4	6	8	10	13	17	22	26	32
Max. short-circuit current																		
	240V	[kA]	100	100	100	100	100	100	100	100	100	100	50	50	40	30	30	20
	480Y/277V	[kA]	50	50	50	50	50	50	50	50	25	25	10	10	10	10	7.5	7.5
	600Y/347V	[kA]	10	10	10	10	10	10	10	5	5	5	5	5	5	5	5	5
Motor load																		
1 Phase	115V	[HP]	-	-	-	-	-	-	-	1/8	1/4	1/3	1/2	1/2	1	2	2	2
	230V	[HP]	-	-	-	-	-	1/10	1/6	1/3	3/4	1	1½	2	3	3	5	5
3 Phase	230V	[HP]	-	-	-	-	-	1/3	1/2	1	1½	2	3	3	5	7½	7½	10
	460V	[HP]	-	-	-	-	1/2	3/4	1½	2	5	5	7½	7½	10	15	15	20
	575V	[HP]	-	-	-	-	1/2	1	1½	3	5	5	10	10	15	20	20	30
Max. fuse size		[A]	1	1	1	1	3	6	10	15	20	30	40	50	60	80	100	125
Max. breaker size		[A]	15	15	15	15	15	15	15	15	20	30	40	50	60	80	100	125

● GMS-32H

Rated operational current I _e		[A]	0.16	0.25	0.4	0.63	1	1.6	2.5	4	6	8	10	13	17	22	26	32
Max. short-circuit current																		
	240V	[kA]	100	100	100	100	100	100	100	100	100	100	100	100	100	100	100	100
	480Y/277V	[kA]	50	50	50	50	50	50	50	50	50	50	50	50	30	30	30	30
	600Y/347V	[kA]	10	10	10	10	10	10	10	10	10	10	10	10	10	10	10	10
Motor load																		
1 Phase	115V	[HP]	-	-	-	-	-	-	-	1/8	1/4	1/3	1/2	1/2	1	2	2	2
	230V	[HP]	-	-	-	-	-	1/10	1/6	1/3	3/4	1	1½	2	3	3	5	5
3 Phase	230V	[HP]	-	-	-	-	-	1/3	1/2	1	1½	2	3	3	5	7½	7½	10
	460V	[HP]	-	-	-	-	1/2	3/4	1½	2	5	5	7½	7½	10	15	15	20
	575V	[HP]	-	-	-	-	1/2	1	1½	3	5	5	10	10	15	20	20	30
Max. fuse size		[A]	1	1	1	1	3	6	10	15	20	30	40	50	60	80	100	125
Max. breaker size		[A]	15	15	15	15	15	15	15	15	20	30	40	50	60	80	100	125

● GMS-63S

Rated operational current I _e		[A]	10	13	17	22	26	32	40	50	63
Max. short-circuit current											
	240V	[kA]	100	100	100	100	100	100	100	100	100
	480Y/277V	[kA]	25	25	25	25	25	25	25	25	25
	600Y/347V	[kA]	10	10	10	10	10	10	10	10	10
Motor load											
1 Phase	115V	[HP]	1/2	1/2	1	2	2	3	3	5	5
	230V	[HP]	1½	2	3	3	5	5	7½	10	15
3 Phase	230V	[HP]	3	3	5	7½	10	10	15	15	20
	460V	[HP]	7½	7½	10	15	20	25	30	40	50
	575V	[HP]	10	10	15	20	25	30	40	50	60
Max. fuse size		[A]	40	50	60	80	100	125	150	200	250
Max. breaker size		[A]	40	50	60	80	100	125	150	200	250



● GMS-63H

Rated operational current I _e	[A]		10	13	17	22	26	32	40	50	63
Max. short-circuit current											
240V	[kA]		100	100	100	100	100	100	100	100	100
480Y/277V	[kA]		50	50	50	50	50	50	50	50	50
600Y/347V	[kA]		10	10	10	10	10	10	10	10	10
Motor load											
1 Phase	115V	[HP]	1/2	1/2	1	2	2	3	3	5	5
	230V	[HP]	1½	2	3	3	5	5	7½	10	15
3 Phase	230V	[HP]	3	3	5	7½	10	10	15	15	20
	460V	[HP]	7½	7½	10	15	20	25	30	40	50
	575V	[HP]	10	10	15	20	25	30	40	50	60
Max. fuse size	[A]		40	50	60	80	100	125	150	200	250
Max. breaker size	[A]		40	50	60	80	100	125	150	200	250



● GMS-100S

Rated operational current I _e	[A]		17	22	26	32	40	50	63	75	90	100
Max. short-circuit current												
240V	[kA]		100	100	100	100	100	100	100	100	100	100
480Y/277V	[kA]		25	25	25	25	25	25	25	25	25	25
600Y/347V	[kA]		10	10	10	10	10	10	10	10	10	10
Motor load												
1 Phase	115V	[HP]	1	1½	2	3	3	5	5	7½	10	10
	230V	[HP]	3	3	5	5	7½	10	15	15	20	20
3 Phase	230V	[HP]	5	7½	10	10	15	15	20	25	30	40
	460V	[HP]	10	15	20	25	30	40	50	60	75	75
	575V	[HP]	15	20	25	30	40	50	60	75	100	100
Max. fuse size	[A]		60	80	100	125	150	200	250	300	350	400
Max. breaker size	[A]		60	80	100	125	150	200	250	300	350	400



● GMS-100H

Rated operational current I _e	[A]		17	22	26	32	40	50	63	75	90	100
Max. short-circuit current												
240V	[kA]		100	100	100	100	100	100	100	100	100	100
480Y/277V	[kA]		50	50	50	50	50	50	50	50	50	50
600Y/347V	[kA]		10	10	10	10	10	10	10	10	10	10
Motor load												
1 Phase	115V	[HP]	1	1½	2	3	3	5	5	7½	10	10
	230V	[HP]	3	3	5	5	7½	10	15	15	20	20
3 Phase	230V	[HP]	5	7½	10	10	15	15	20	25	30	40
	460V	[HP]	10	15	20	25	30	40	50	60	75	75
	575V	[HP]	15	20	25	30	40	50	60	75	100	100
Max. fuse size	[A]		60	80	100	125	150	200	250	300	350	400
Max. breaker size	[A]		60	80	100	125	150	200	250	300	350	400

Technical Information

General data



Type		GMS-32S
Rated insulation voltage		
IEC		690V
UL, CSA		600V
Rated impulse withstand voltage		
Uimp/Pollution degree		6kV / 3
Rated frequency		50 / 60 Hz
Utilization category:		
IEC 947-2 (Circuit breaker)		Cat. A
IEC 947-4-1 (Motor starter)		AC 3
Life span		
Mechanical	Operations	100,000
Electrical(I _e max.)	Operations	100,000
Switching frequency		
	Ope./h	25
Ambient temperature		
Storage	°C	-50 ~ +80
Operation	°C	-20 ~ +60
Operation altitude		
	m	Up to 2000 (6500 Feet)
Protection class		
		IP 20
		Safe from finger touch
Resistance to shock		
	g	25
Resistance to vibration		
	Hz	5 ~ 150
Rated thermal current I_{th}		
IEC	[A]	0.1 ... 32
up to 60°C ambient temperature		
Overload protection		
Characteristics		○
Ambient temperature compensation		
		-20 ~ +60
Phase-failure protection		
		○
Trip class		
	IEC 60947-4-1	10
Magnetic release		
Response current		13 × I _n ²⁾
Total power loss P_v		
Circuit breaker at rated load	[W]	I _n = 0.16~4A : 9.8
Operating temperature		I _n = 6~26A : 8
		I _n = 32A : 3.9

Note = 1) Class20; GMS-63HL, GMS-100HL

2) I_n = Max. rated operational current I_e







GMS-32H	GMS-63S, 63H	GMS-100S, 100H
690V	1000V	1000V
600V	600V	600V
6kV / 3	8kV / 3	8kV / 3
50 / 60 Hz	50 / 60 Hz	50 / 60 Hz
Cat. A AC 3	Cat. A AC 3	Cat. A AC 3
100,000	50,000	50,000
100,000	25,000	25,000
25	25	25
-50 ~ +80	-50 ~ +80	-50 ~ +80
-20 ~ +60	-20 ~ +60	-20 ~ +60
Up to 2000 (6500 Feet)	Up to 2000 (6500 Feet)	Up to 2000 (6500 Feet)
IP 20	IP 20	IP 20
Safe from finger touch	Safe from finger touch	Safe from finger touch
25	25	25
5 ~ 150	5 ~ 150	5 ~ 150
0.1 ... 32	6 ... 63	11 ... 100
○	○	○
-20 ~ +60	-20 ~ +60	-20 ~ +60
○	○	○
10	10 ¹⁾	10 ¹⁾
$13 \times I_n^{2)}$	$13 \times I_n^{2)}$	$13 \times I_n^{2)}$
$I_n = 0.16\sim 4A : 9.8$ $I_n = 6\sim 26A : 8$ $I_n = 32A : 3.9$	$I_n = 10\sim 22A : 13.3$ $I_n = 26\sim 63A : 12.6$	$I_n = 17\sim 63A : 11.9$ $I_n = 75\sim 100A : 15$

Specifications are subject to change without notice.

General data

● Manual Motor Starter GMS-32...100

	GMS-32S	GMS-32H	GMS-32S, 63H	GMS-100S, 100H
Conformity to standards	IEC60947 UL508, UL508 Type E			
Approvals	CE, UL			
Terminal parts				
Screwdriver				
Single-core	1.conductor [mm] / [AWG]	1...10 / 18...8	1...10 / 18...8	0.75...35 / 18...2
	2.conductor [mm] / [AWG]	1...6 / 18...10	1...6 / 18...10	0.75...25 / 18...4
Stranded	1.conductor [mm] / [AWG]	1...6 / 18...10	1...6 / 18...10	0.75...35 / 18...2
	2.conductor [mm] / [AWG]	1...6 / 18...10	1...6 / 18...10	0.75...25 / 18...4
Flexible	1.conductor [mm] / [AWG]	1...6 / 18...10	1...6 / 18...10	0.75...25 / 18...4
	2.conductor [mm] / [AWG]	0.75...4 / 18...10	0.75...4 / 18...10	0.75...16 / 18...6
Tightening torque [Nm] / [lb-in]		0.8...2.5 / 7...22	0.8...2.5 / 7...22	3...4.5 / 26...39
				4...6 / 35...53

● Accessories for Manual Motor Starter GMS-32...100

	Auxiliary contacts for front mounting GFX...	Auxiliary contacts for left side mounting GSX...	Alarm switch for left side mounting GSA...
Rated thermal current / th			
at 40°C ambient temperature [A]	5	1 0	1 0
at 60°C ambient temperature [A]	3	6	6
Contact class coordination according to NEMA (UL/CSA-Standards)			
AC	B 600 Standard Pilot Duty	A 600 Standard Pilot Duty	A 600 Standard Pilot Duty
DC	R 300 Light Pilot Duty	Q 300 Light Pilot Duty	Q 300 Light Pilot Duty
Back-up fuses gG, gL [A]	16	1 6	1 6
Rated supply current [V]	24 240	24 240	24 240
AC-15: [A]	3 2	6 4	6 4
DC-13: [V]	24 220	24 220	24 220
	[A] 1 0.1	2 0.25	2 0.25
Terminal parts			
Type of terminals			
Screwdriver		Pozidriv size 2	
Single-core	1.conductor [mm] / [AWG]	0.5...2.5 / 20...14	
	2.conductor [mm] / [AWG]	0.5...2.5 / 20...14	
Flexible	1.conductor [mm] / [AWG]	0.5...4 / 20...10	
	2.conductor [mm] / [AWG]	0.75...2.5 / 18...14	
Tightening torque [Nm] / [lb-in]		0.8...1.2 / 7...10	

● Accessories for Manual Starter GMS-32...100

	Undervoltage release for right side mounting GUR...	Undervoltage release with 2 auxiliary contacts for right side mounting GURX...	Shunt release for right side mounting GSR...
Actuating voltage			
Pull-in	0.85...1.1 × Us	0.85...1.1 × Us	0.7...1.1 × Us
Drop-out	0.7...0.35 × Us	0.7...0.35 × Us	
Rated control voltage			
min.:	24V 50Hz / 28V 60Hz	24V 50Hz / 28V 60Hz	24V 50Hz / 28V 60Hz
max.:	415~440V 50Hz / 460~480V 60Hz	415~440V 50Hz / 460~480V 60Hz	415~440V 50Hz / 460~480V 60Hz
Coil rating			
Pull-in	8.5VA, 6W	8.5VA, 6W	8.5VA, 6W
Hold	3VA, 1.2W	3VA, 1.2W	3VA, 1.2W
On-Time	100%	100%	100%
Terminal parts			
Type of terminals			
Screwdriver		Pozidriv size 2	
1.conductor [mm] / [AWG]		0.5...2.5 / 20...14	
2.conductor [mm] / [AWG]		0.5...2.5 / 20...14	
1.conductor [mm] / [AWG]		0.5...4 / 20...10	
2.conductor [mm] / [AWG]		0.75...2.5 / 18...14	
Tightening torque [Nm] / [lb-in]		0.8...1.2 / 7...10	

● Weights

Description	Type	Weight [g]
Circuit breaker	GMS-32S	320
	GMS-32H	360
	GMS-63S	1,000
	GMS-100S	2,200
Auxiliary switch	GFX... (Front Auxiliary Switch)	18
	GSX... (Side Auxiliary Switch)	30
	GSA... (Alarm Switch)	40
Undervoltage release	GUR... (Undervoltage release)	110
	GURX... (Undervoltage release with 2 auxiliary contacts)	120
Shunt release	GSR... (Shunt release)	110

Type '2' coordination according to IEC 947-4-1

- Short-circuit current $I_q = 50\text{kA}$
Voltage : 400/415V, 50/60Hz

Standard motors AC-3 at 400/415V 1500rpm		Manual motor starter			Contactor	
[kW]	[A]	Circuit breaker Type	Thermal overload release setting range [A]	Magnetic release response current [A]	Type	[A]
0.06	0.24	GMS-32S 0.25A	0.16 ~0.25	3.25	CGMS-6	6
0.09	0.33	GMS-32S 0.4A	0.25~0.4	5.2	CGMS-6	6
0.12	0.43	GMS-32S 0.63A	0.4~0.63	8.19	CGMS-6	6
0.18	0.61	GMS-32S 0.63A	0.4~0.63	8.19	CGMS-6	6
0.25	0.8	GMS-32S 1A	0.63~1	13	CGMS-6	6
0.37	1.1	GMS-32S 1.6A	1~1.6	20.8	CGMS-6	6
0.55	1.5	GMS-32S 1.6A	1~1.6	20.8	CGMS-6	6
0.75	1.9	GMS-32S 2.5A	1.6~2.5	32.5	CGMS-9/CGC-9	9
1.1	2.7	GMS-32S 4A	2.5~4	52	CGMS-9/CGC-9	9
1.5	3.5	GMS-32S 4A	2.5~4	52	CGMS-12/CGC-12	12
2.2	5.0	GMS-32S 6A	4~6	78	CGC-18	18
3.0	6.6	GMS-32S 8A	5~8	104	CGC-18	18
4.0	8.5	GMS-32S 10A	6~10	130	CGC-18	18
5.5	11.0	GMS-32S 13A	9~13	169	CGC-22	22
7.5	15.0	GMS-32H 17A	11~17	221	CGC-22	22
10.0	20.0	GMS-32H 22A	14~22	286	CGC-32	32
11.0	22.0	GMS-32H 26A	18~26	338	CGC-32	32
15.0	29.0	GMS-32H 32A	22~32	416	CGC-32	32
18.5	36.0	GMS-63S 40A	28~40	520	CGC-50	50
22.0	41.0	GMS-63S 50A	34~50	650	CGC-50	50
30.0	56.0	GMS-63S 63A	45~63	819	CGC-65	65
37.0	68.0	GMS-100S 75A	55~75	975	CGC-75	75
-	-	GMS-100S 90A	70~90	1170	CGC-85	85
45.0	81.0	GMS-100S 100A	80~100	1300	CGC-85	85

Definition type '2' coordination according to IEC 947-4-1

- The contactor or the starter must not endanger persons or systems in the event of a short-circuit.
- The contactor or the starter must be suitable for further use.
- No damage to the overload relay or other parts may occur with the exception of welding of the contactor or starter contacts provided that these can be easily separated without significant deformation (such as with a screwdriver).

Time/Current characteristic

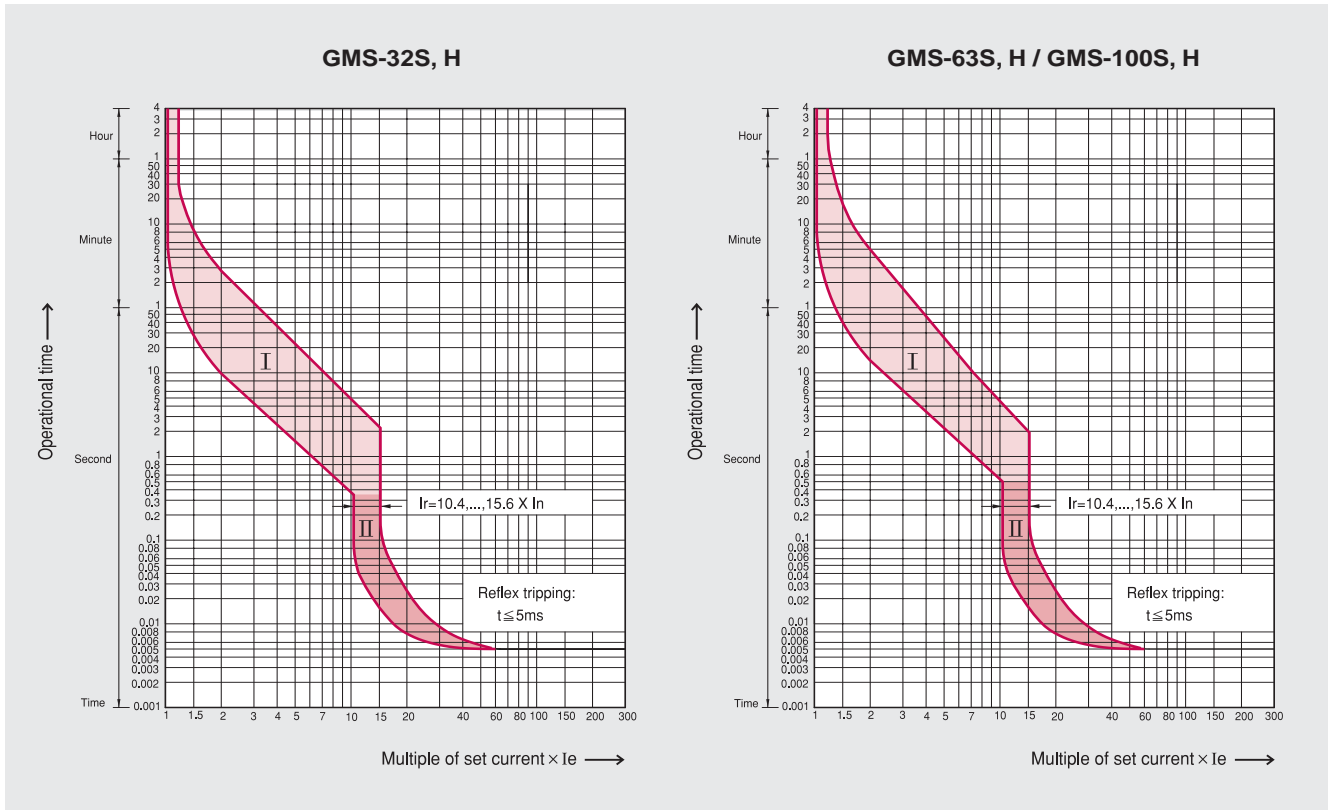

I) Thermal release trip current :

The adjustable inverse bimetal trip reliability protects motors against overloads. The curve shows the mean operating current at an ambient temperature of 20 °C starting from cold. Careful testing and setting ensures effective motor protection even in the case of single-phasing.

II) Magnetic release trip current :

The instantaneous magnetic trip has a fixed operating current setting. This corresponds to 13times the maximum value of setting range, at a lower setting it is correspondingly higher.

Current setting Ie :

The overload trip corresponds to a thermal overload relay in a motor starter conforming to IEC 947-4-1. If a different value is prescribed (e.g. reduced Ie for cooling medium having a temperature higher than 40 °C or a place of installation higher than 2000m above sea level), the setting current is equal to the reduced rated current Ie of the motor.

● GMS-32S

[mm]

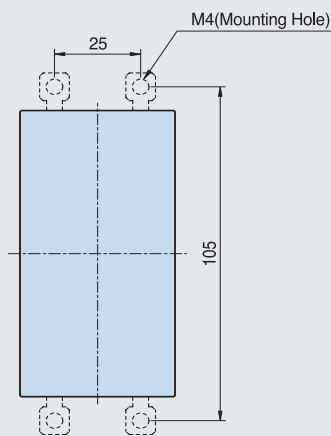
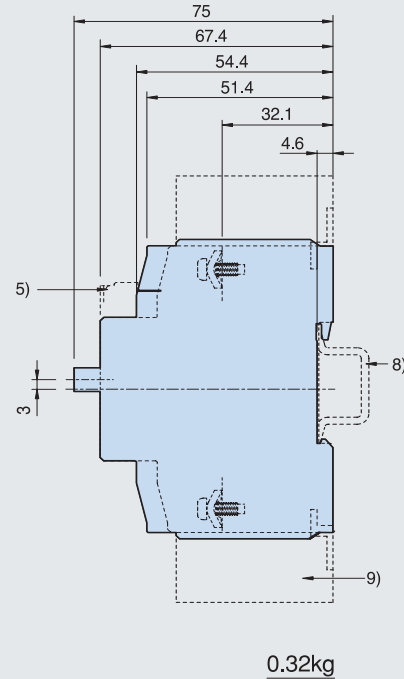
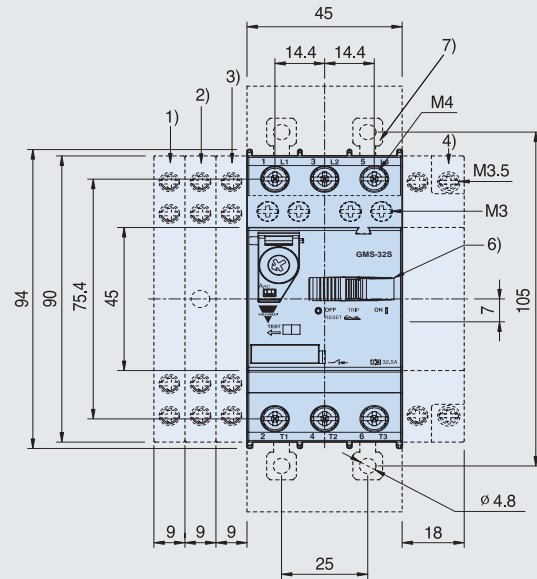

- 1) Side auxiliary switch
- 2) Side magnetic trip alarm switch
- 3) Side any trip alarm switch
- 4) Side shunt release or Side undervoltage release
- 5) Front auxiliary switch
- 6) Handle lock in OFF position (∅ 5mm)
- 7) Push-in Lugs for screw mounting
- 8) 35mm standard mounting rail acc. to EN 50 022
- 9) Arcing space

Height of arcing spaces
(Clearance from earthed parts)

Ue[V]	240	415	460	525	690
[mm]	20	20	20	20	20

Arcing spaces for limiter function

Ue[V]	525		690	
	left/right	top/bottom	left/right	top/bottom
[mm]	10	40	30	50

● GMS-32H, 32HI

[mm]

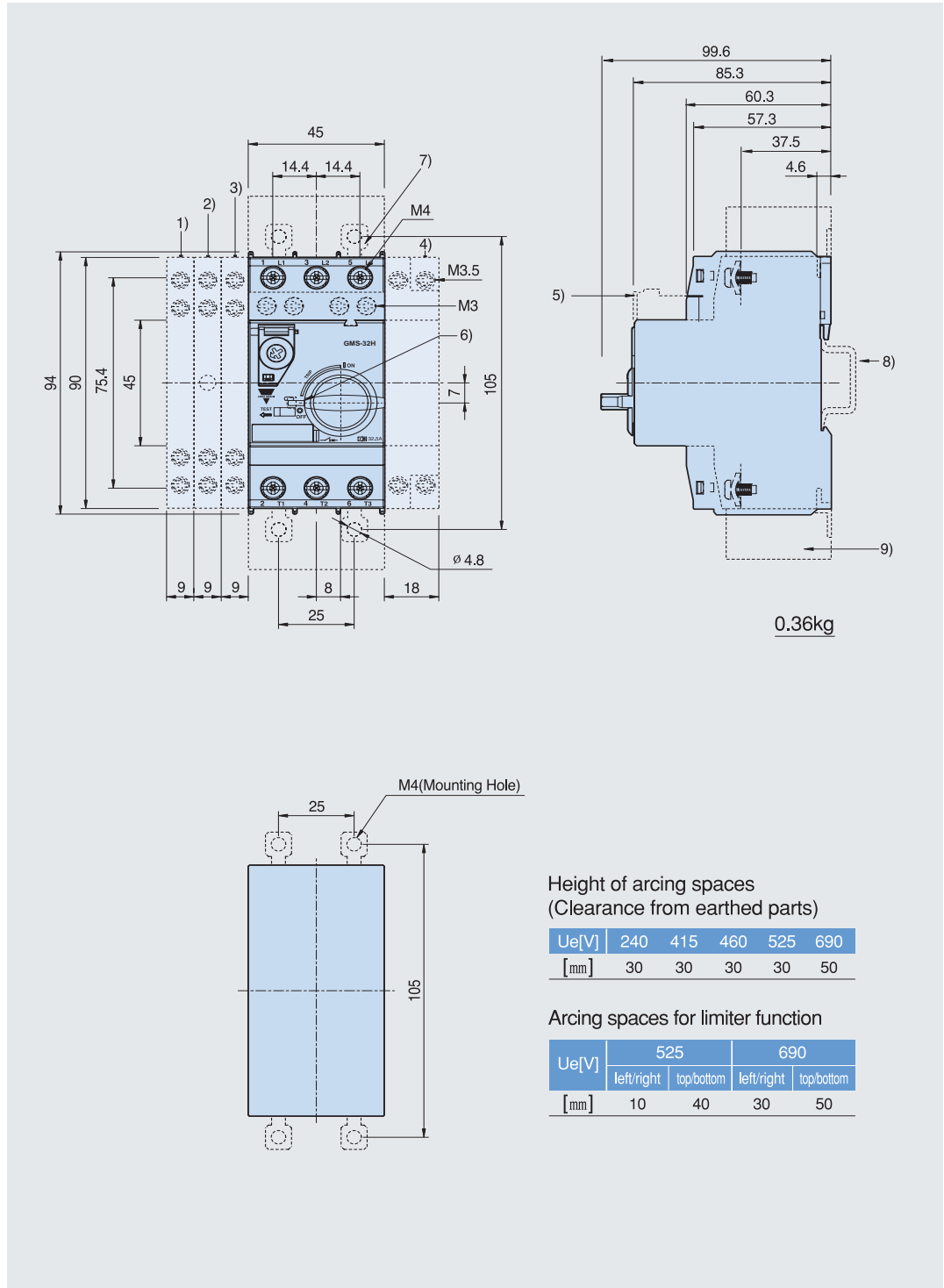

● GMS-63S, 63H, 63HI, 63HL

[mm]

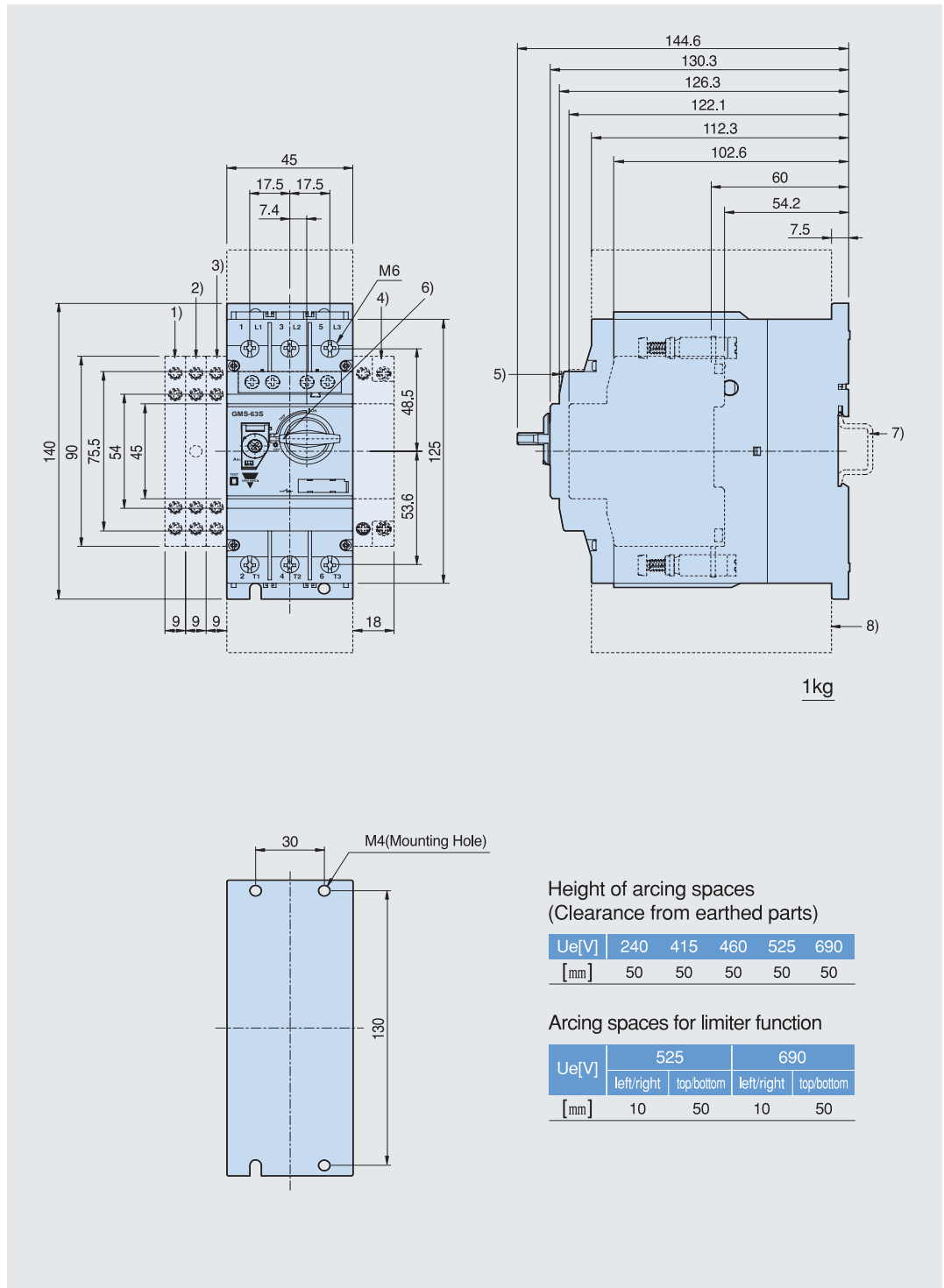

- 1) Side auxiliary switch
- 2) Side magnetic trip alarm switch
- 3) Side any trip alarm switch
- 4) Side shunt release or Side undervoltage release
- 5) Front auxiliary switch
- 6) Handle lock in OFF position(\varnothing 5mm)
- 7) 35mm standard mounting rail acc. to EN 50 022
- 8) Arcing space

● GMS-100S, 100H, 100HI, 100HL

[mm]

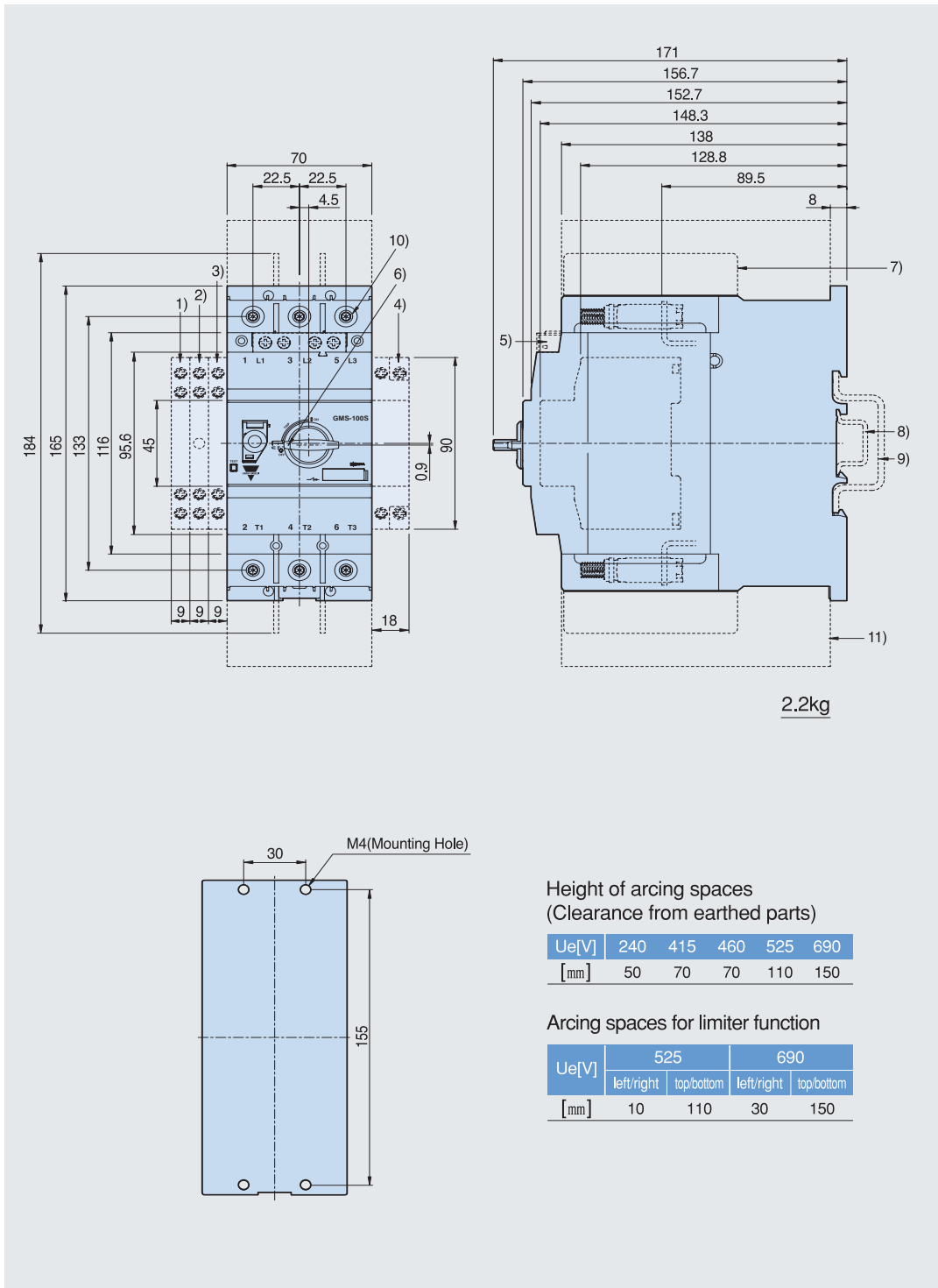

- 1) Side auxiliary switch
- 2) Side magnetic trip alarm switch
- 3) Side any trip alarm switch
- 4) Side shunt release or Side undervoltage release
- 5) Front auxiliary switch
- 6) Handle lock in OFF position(\varnothing 5mm)
- 7) Insulation barrier
- 8) 35mm standard mounting rail acc. to EN 50 022
- 9) 75mm standard mounting rail acc. to EN 50 023
- 10) 4mm hexagon socket screw
- 11) Arcing space

Specifications are subject to change without notice.



www.GavazziOnline.com

www.GavazziOnline.com is an information filled website which offers you the ability to download data sheets, specify products, check pricing and availability, track shipping and so much more:

Easy-to-use Product Selection Guides



Download Brochures



Industry Specific Brochures/Flyers



New Product Press Releases



Latest Events



Data Sheets



Industry Specific Web Pages



User Manuals

