

Photoelectrics Through-beam, Transistor Output Type PC50CNT20B.

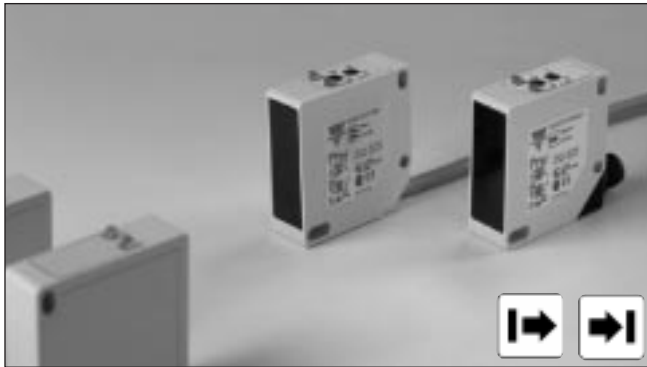

- Range: 20 m
- Adjustable sensitivity
- Modulated, infrared light
- Supply voltage: 10 to 30 VDC
- Output: 200 mA, NPN or PNP selectable
- Make and break switching function
- LED for output indication, signal stability and power ON
- Protection: reverse polarity, short circuit, transients
- Cable and plug versions
- High EMC immunity

Preliminary data sheet Product Description

The PC50CNT. is a family of general purpose through-beam sensors in a compact square 17 x 50 x 50 mm reinforced PC/ABS-housing. They are useful in applications where basic sensors provide adequate sensing performance.

The long sensing range together with sensitivity adjustment gives a very flexible sensor. The DC types are with a transistor output and the configuration is fully programmable (NPN, PNP, NO and NC).

Ordering Key **PC50CNT20BAM1**

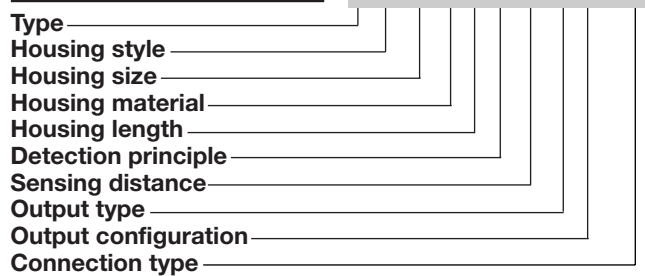

Type Selection

Housing W x H x D	Range S _n	Connection	Ordering no. Receiver NPN & PNP Make & break switching	Ordering no. Emitter
17 x 50 x 50 mm	20 m	Cable	PC 50 CNT 20 BA	PC 50 CNT 20 B
17 x 50 x 50 mm	20 m	Plug	PC 50 CNT 20 BAM1	PC 50 CNT 20 BM1

Note: Please order emitter and receiver separately

Specifications Emitter

Rated operational volt. (U _B)	10 to 30 VDC	Light source	GaAs LED, 950 nm
Ripple (V _{rrp})	≤ 10%	Light type	Infrared, modulated
Supply current	≤ 50 mA	Optical angle	± 2°
Protection	Reverse polarity, transients	Indication function	LED, green
		Power supply ON	

Specifications Receiver

Rated operating dist. (S _n)	20 m	OFF-state current (I _r)	≤ 100 µA
Blind zone	None	Voltage drop (U _d)	≤ 2.5 VDC @ 200 mA
Sensitivity	Adj. by single-turn pot.meter	Protection	Short-circuit, reverse polarity, transients
Temperature drift	± 0.5%/°C	Operating frequency (f)	500 Hz
Hysteresis (H)	3 - 20%	Response time	OFF-ON (t _{ON}) ≤ 1 ms ON-OFF (t _{OFF}) ≤ 1 ms
Rated operational volt. (U _B)	10 to 30 VDC (ripple included)	Power ON delay (t _v)	≤ 300 ms
Ripple (V _{rrp})	≤ 10%	Output function	NPN and PNP Complementary switch Switch selectable Make and break (NO + NC)
Output current		Indication function	
Continuous (I _e)	≤ 200 mA	Output ON	LED, yellow
Short-time (I)	≤ 200 mA, (max. load capacity 100 nF)	Signal stability ON and power ON	LED, green
No load supply current (I _o)	≤ 50 mA		
Minimum operational current (I _m)	0.5 mA		



General Specifications

Environment		Housing material	
Overvoltage category	II (IEC 60664/60664A, 60947-1)	Body	PC/ABS, grey
Pollution degree	3 (IEC 60664/60664A, 60947-1)	Front glass	PC black
Degree of protection	IP 67 (IEC 60529, 60947-1)	Mounting bracket	Steel, galvanized
Temperature		Connection	
Operating	-20° to +60°C (-4° to +140°F)	Cable receiver	PVC, grey, 2 m, 4 x 0.25 mm ²
Storage	-25° to +80°C (-13° to +176°F)	Cable emitter	PVC, grey, 2 m, 2 x 0.25 mm ²
Vibration		Plug (M1)	PBTP, M12 x 1
10 to 150 Hz, 0.5 mm/7.5 g (IEC 60068-2-6)		Cables for plug (M1)	CON.1A-series
Shock		Weight	
2 x 1 m & 100 x 0.5 m (IEC 60068-2-32)		Emitter	130 g
Rated insulation voltage		Receiver	130 g
50 VDC		CE-marking	Yes

Operation Diagram

tv = Power ON delay

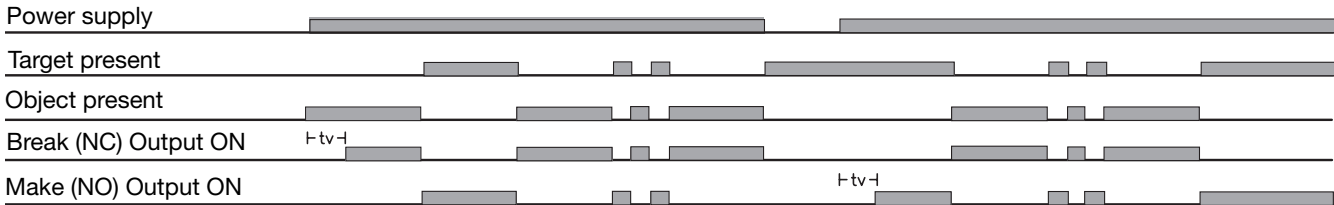

Dimensions

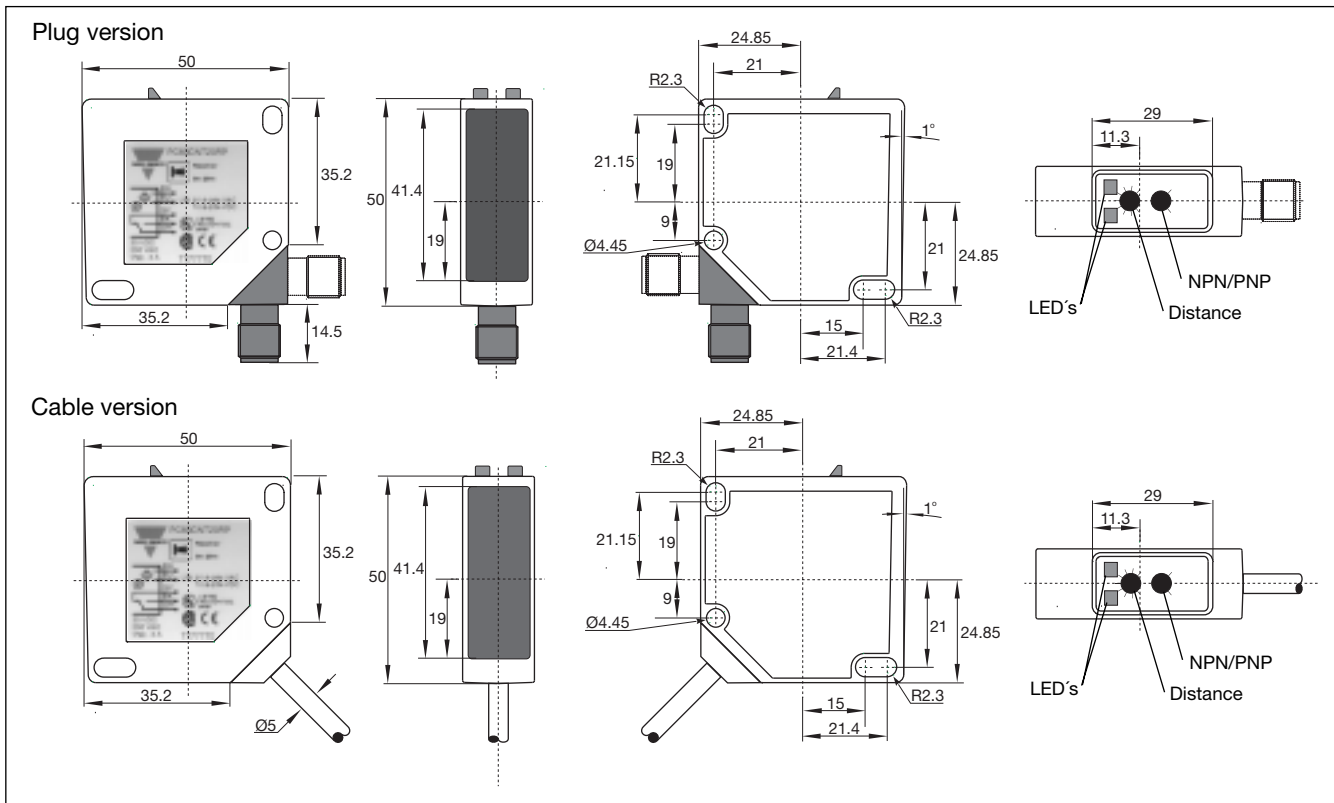

Wiring Diagrams

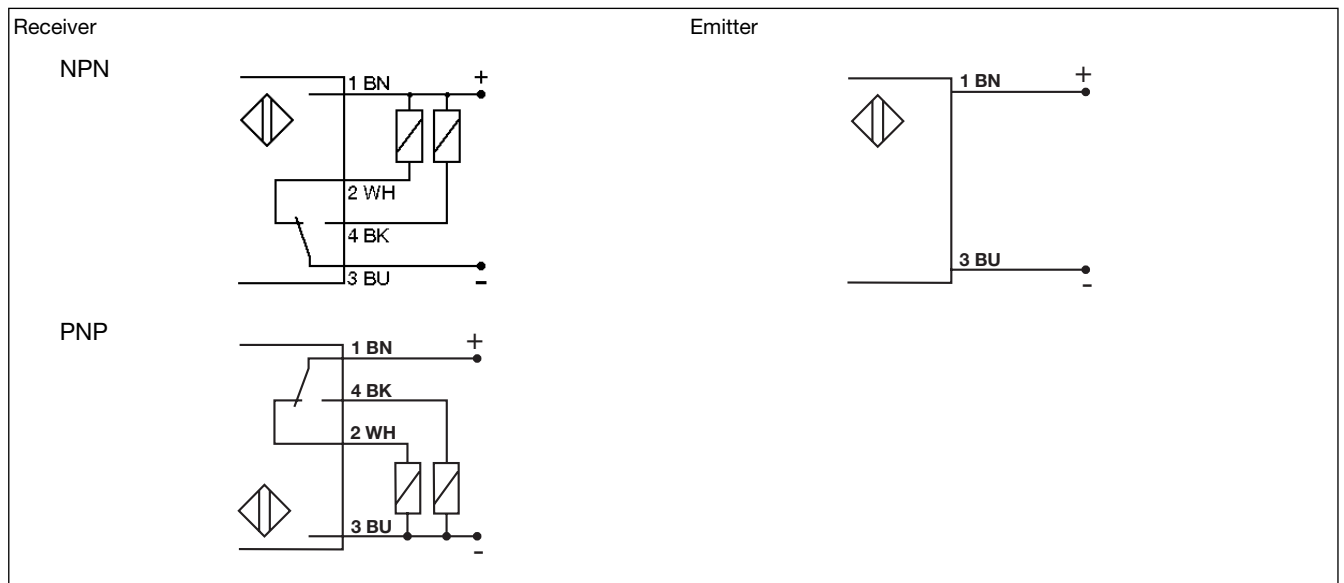

Detection Diagram

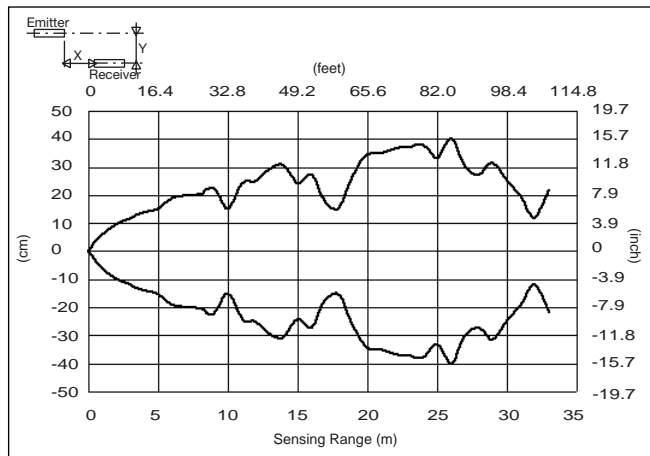

Signal Stability

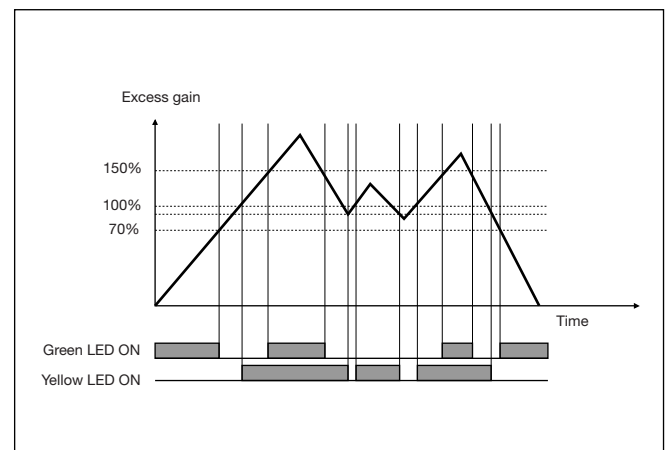

Excess Gain

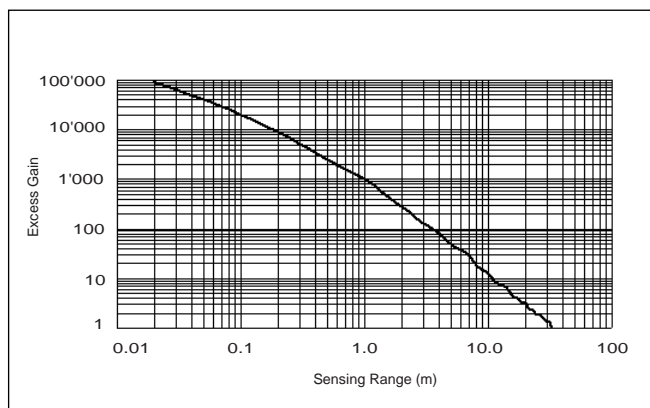

Delivery Contents

- Photoelectric switch: PC50CNT..
- Installation instruction
- Mounting bracket APC50-1
- **Packaging:** Cardboard box

Accessories

- Screwdriver 77.067